

NEOLITH

touch.feel.live



KITCHEN + BATHROOM

What is Neolith?
¿Qué es Neolith?

Neolith, a Carbon Neutral Company
Neolith, una compañía Carbon Neutral

Environmental Fact Sheet
Hoja de Datos Ambientales

Certifications and Awards
Certificados y Premios

Formats, applications and thicknesses
Formatos, aplicaciones y espesores

Finishes
Acabados

Models only available for projects
Modelos solo disponibles para proyectos

Bookmatch & Endmatch

Design variants in 6 mm
Variantes de diseño en 6 mm

General Summary
Resumen General

ABOUT NEOLITH

P. 05

KITCHEN

P. 26

BATHROOM

P. 108

NEOLITH GALLERY

P. 152

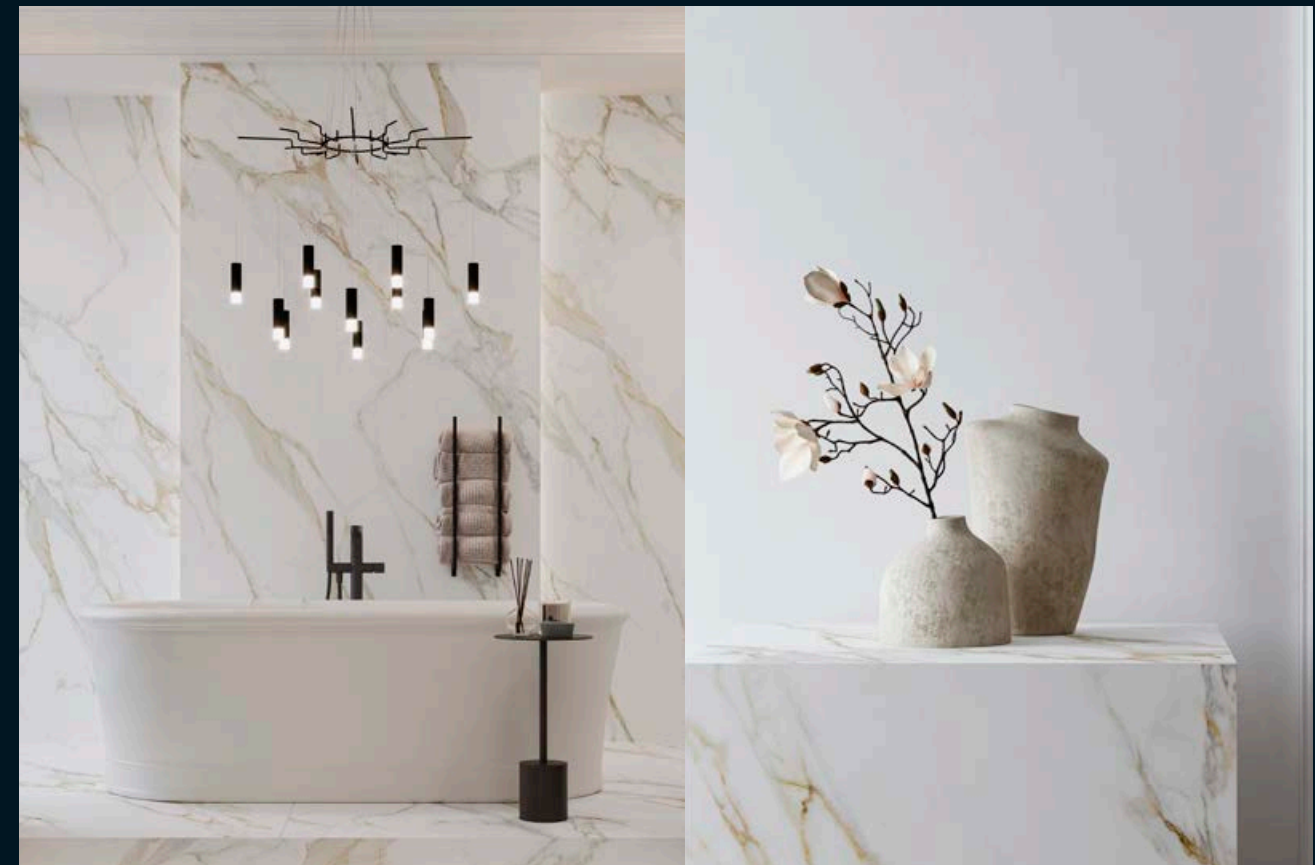
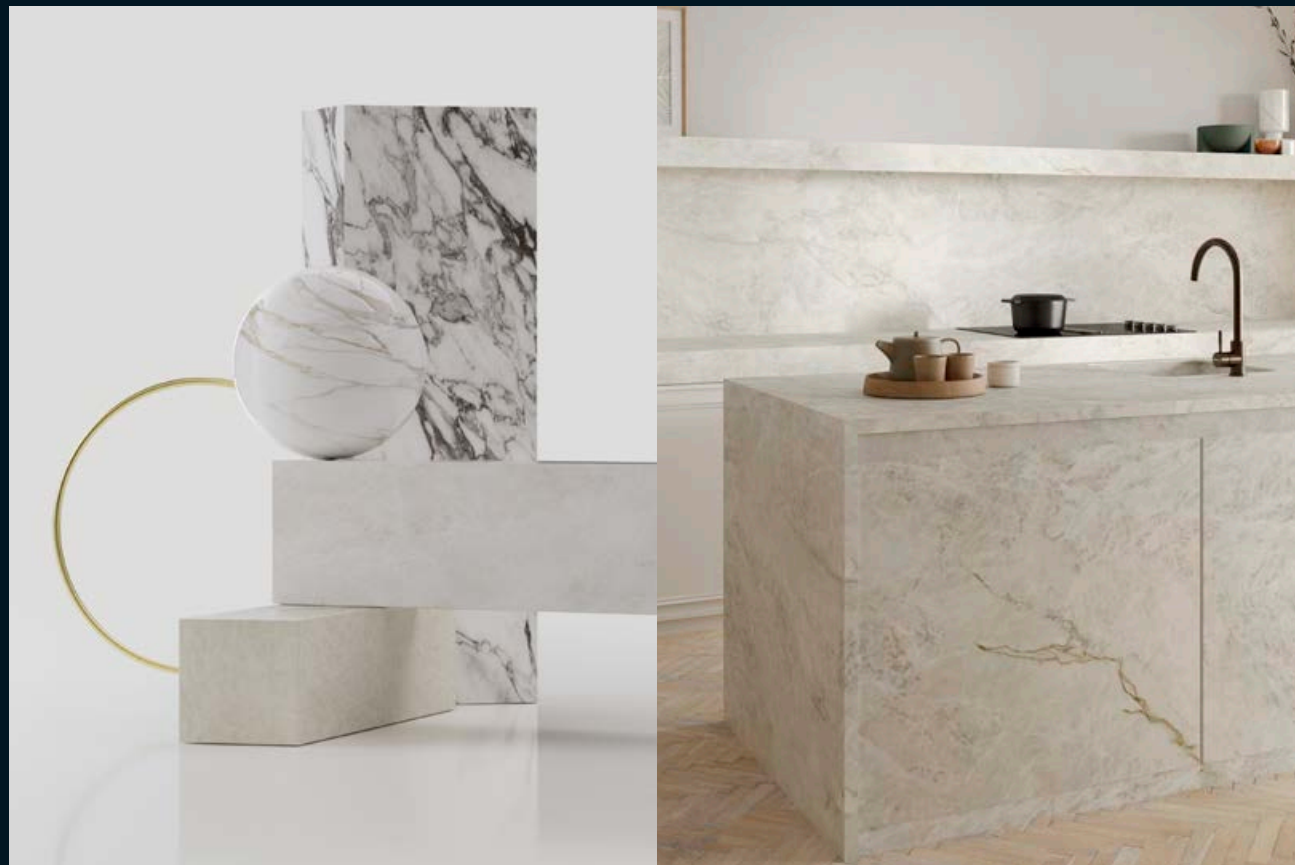



NEOLITH
touch.feel.live

Everything we do, say and think at Neolith is centered on the end user. We specialize in finding the essential balance that should always exist between functionality and design, to create unique spaces that help us live better. Because

the best thing about creating something, is living it.

En Neolith, todo lo que hacemos, decimos o pensamos está centrado en el consumidor. Estamos especializados en alcanzar el equilibrio imprescindible que siempre debe existir entre funcionalidad y diseño, para crear espacios únicos que nos ayuden a vivir mejor. Porque

lo mejor de crear algo, es vivirlo.

What is Neolith?

Neolith is a revolutionary and innovative architectural surface with superior technical characteristics made of natural raw materials. It is synonymous to quality, versatility, durability and sustainability as well as class, elegance, style and subtleness.

As a result of innovation efforts to meet its main objectives intrinsically tied to sustainability, Neolith strives to promote new trends in interior design and architecture to satisfy the most demanding needs of both professionals and end consumers.

Neolith inspires unique, functional and sustainable solutions for indoor and outdoor spaces and creates extraordinary experiences through the most cutting-edge surfaces. It is the brand of choice for architects, designers and homeowners and the preferred partner for installers.

¿Qué es Neolith?

Neolith es una superficie arquitectónica revolucionaria e innovadora con características técnicas superiores, fabricada con materias primas naturales. Es sinónimo de calidad, versatilidad, durabilidad y sostenibilidad así como de clase, elegancia, estilo y sutileza.

Como resultado de un esfuerzo de innovación para cumplir sus principales objetivos, intrínsecamente ligados a la sostenibilidad, Neolith tiene como objetivo impulsar las nuevas tendencias del interiorismo y la arquitectura para satisfacer las necesidades más exigentes, tanto de los profesionales como del consumidor final.

Neolith inspira soluciones únicas, funcionales y sostenibles para espacios de interior y exterior y genera experiencias extraordinarias a través de las superficies más innovadoras. Es la marca elegida por arquitectos, diseñadores y propietarios y el socio preferido de los instaladores.

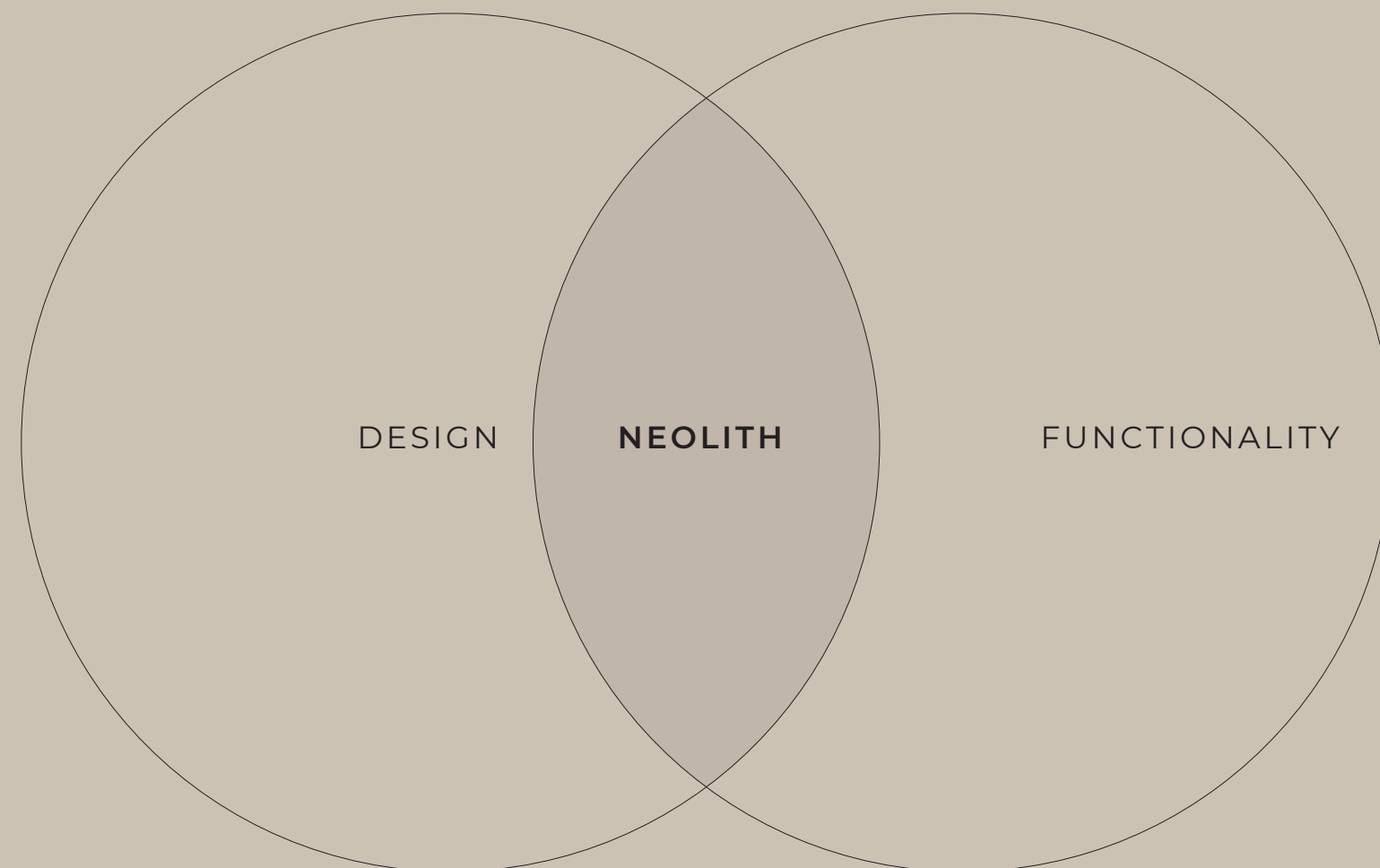

Neolith, a Carbon Neutral Company

THE LEADING SURFACES BRAND IS ONE OF THE MOST SUSTAINABLE MATERIALS ON THE MARKET.

Neolith's main goal is carbon neutrality, which the company reached in 2019 for its main carbon footprint scopes, positioning itself as one of the greenest architectural surface solutions.

Neolith's sustainability agenda remains a priority and the company is constantly demonstrating an unwavering commitment to the decarbonization of its products and to a circular economy. To achieve the Carbon Neutral certification, Neolith followed the internationally recognized GHG Protocol and has a firm sustainability strategy in place to offset the carbon emissions generated.

On the other hand, Neolith is committed to achieving maximum efficiency in the use of resources and new technologies. The main resources required for the Group's activities are raw materials and energy.

That's why Neolith is 100% recyclable and some of its models are produced with up to 98% recycled materials. Moreover, the company has an excellent waste management system in place, which recycles and reuses more than 96% of the industrial waste generated. 100% of the electricity used in the production process comes from renewable sources and all the industrial water consumed is recycled.

Product life Cycle

CARBON NEUTRALITY FROM START TO FINISH

Neolith surfaces are designed and manufactured from a circular economy perspective to maximize protection and well-being for people and the planet. Neolith is leading the sustainability path to inspire and enable all stakeholders throughout its value chain. The company creates stunning surfaces designed for the best performance and product circularity.

The continuous improvement criteria have enabled relevant awards and certifications, making Neolith a unique category. It ensures the highest commitment to environmental matters and circularity from cradle to cradle.

Neolith, una compañía Carbon Neutral

LA MARCA LÍDER DE SUPERFICIES ES UNO DE LOS MATERIALES MÁS SOSTENIBLES DEL MERCADO.

Alcanzar la Neutralidad en Carbono es la carta de presentación de Neolith, objetivo que la compañía consiguió en 2019 para los principales alcances de su huella de carbono, situándose como una de las soluciones de superficies arquitectónicas más verdes.

La agenda de sostenibilidad de Neolith es una prioridad y la firma está demostrando constantemente su firme compromiso con la descarbonización de sus productos y también para conseguir una economía circular. Para alcanzar el reconocimiento de Neutralidad en Carbono, Neolith ha seguido el Protocolo GHG, reconocido internacionalmente, y cuenta con una sólida estrategia de sostenibilidad para compensar las emisiones de carbono generadas.

Por otro lado, Neolith tiene el compromiso de conseguir la máxima eficiencia en el uso de recursos y nuevas tecnologías. Los principales para desarrollar la actividad del Grupo son las materias primas y la energía.

Por eso Neolith es 100% reciclable, algunos de sus modelos están fabricados con hasta un 98% de materiales reciclados y la compañía cuenta con un excelente programa de gestión de residuos, reciclando o reutilizando más del 96% de los residuos industriales que se generan. El 100% de la electricidad utilizada en el proceso productivo procede de fuentes renovables y toda el agua industrial consumida es reciclada.

Ciclo de vida del producto

NEUTRALIDAD EN CARBONO DE PRINCIPIO A FIN

Las superficies Neolith se diseñan y fabrican desde una perspectiva de economía circular para maximizar la protección y el bienestar de las personas y el planeta. Neolith lidera el camino de la sostenibilidad para inspirar y capacitar a todas las partes interesadas a lo largo de su cadena de valor. La empresa crea superficies asombrosas diseñadas para obtener el mejor rendimiento y circularidad del producto.

Los criterios de mejora continua han permitido obtener premios y certificaciones relevantes, lo que convierte a Neolith en una categoría única. Garantiza el máximo compromiso con las cuestiones medioambientales y la circularidad de la cuna a la cuna.



Environmental fact Sheet

ENVIRONMENTAL CARE

Neolith takes a holistic approach to environmental impacts throughout the product life cycle by ensuring responsible management at every stage of the production process. Priority is given to minimizing waste, reducing pollution, preserving natural resources and promoting energy efficiency.

ZERO WASTE

Neolith recovers and recycles more than 96% of the industrial waste generated.

CARBON NEUTRALITY

Since 2019, Neolith has achieved carbon neutrality for its main Scopes and has ongoing CO₂ capture R&D&I projects to achieve Net Zero.

RENEWABLE ENERGIES

100% of the electricity used in the production process comes from self-consumption and sources with a guarantee of origin.

REUSE OF INDUSTRIAL WATER

The water used in the production process is recycled.

96%

of the industrial waste generated is either recycled or reused.

de los residuos industriales son reciclados o reutilizados.

UP TO / HASTA UN

98%

of the content of each slab comes from recycled materials.

del peso de la tabla se obtiene de materiales reciclados.

Hoja de datos ambientales

CUIDADO DEL MEDIO AMBIENTE

Neolith aborda de manera integral los impactos ambientales a lo largo del ciclo de vida del producto, garantizando una gestión responsable en cada fase del proceso de producción. Se prioriza minimizar los residuos, reducir la polución, preservar los recursos naturales y fomentar la eficiencia energética.

RESIDUO CERO

Neolith valoriza y recicla más del 96% de los residuos industriales generados.

NEUTRALIDAD EN CARBONO

Neolith ha logrado la neutralidad de carbono para sus principales alcances y tiene en marcha proyectos de I+D+i de captura de CO₂ para avanzar en el objetivo Net Zero.

ENERGÍAS RENOVABLES

El 100% de la energía eléctrica consumida durante el proceso productivo procede del autoconsumo y de fuentes con garantía de origen renovable.

REUTILIZACIÓN DEL AGUA INDUSTRIAL

El agua empleada en el proceso de producción es reciclada.

-19%

Scope 1 reduction in carbon footprint, taking absolute values for 2023 compared to 2022.

Reducción en alcance 1 de la huella de carbono, tomando valores absolutos 2023 comparado con 2022.

-10%

Scope 2 reduction in carbon footprint, taking absolute values for 2023 compared to 2022.

Reducción en alcance 2 de la huella de carbono, tomando valores absolutos 2023 comparado con 2022.

Environmental fact Sheet

Neolith is an innovative surface with a unique sustainability profile. Design, durability and superior technical properties are combined to create kitchen and bathroom countertops, flooring, cladding, facades and furniture.

The concept of Sustainable Beauty reflects our way of being and creating a better future for all.

PRODUCT COMPOSITION

NATURAL COMPOSITION

Neolith uses the best raw materials: a selection of premium all-natural minerals. Neolith does not add crystalline silica sand, cristobalite or resins to its composition.

98R

Neolith incorporates up to 98% recycled materials in some of its models, preserving their physical and esthetic properties.

RECYCLABLE

Due to the all-natural composition, Neolith products have an extended life cycle and can be recycled at the end of their useful life.

NO ADDED QUARTZ

Neolith's free crystalline silica content in the form of impurities is below 9%, positioning itself in the lowest range on the market.*

* See product technical data sheet

ADDITIONAL SUSTAINABLE BENEFITS

Neolith's unique sintering process provides additional sustainable benefits.

Refurbishment

Neolith can be applied directly to existing surfaces. This saves time, costs and generates less waste to be transported and treated, thereby further reducing net CO₂ emissions.

Optimized energy consumption

Neolith's high resistance to extreme temperatures makes it the ideal material of choice for ventilated facades. The thermal insulation and ventilation between the Neolith facade and the building itself optimizes the building's energy consumption.

25-year warranty

Neolith countertops and slabs do not require frequent replacement or maintenance treatments. That is why Neolith offers a 25-year warranty on its countertops for residential use, subject to registration and according to the terms and conditions outlined in neolith.com/en/warranty

Hoja de datos ambientales

Neolith es una superficie innovadora con un perfil de sostenibilidad único. Diseño, durabilidad y unas propiedades técnicas superiores se combinan para crear encimeras de cocina y baño, suelos, revestimientos, fachadas y mobiliario.

El concepto de Sustainable Beauty refleja nuestra forma de ser y de crear un futuro mejor para todos.

COMPOSICIÓN DE PRODUCTO

COMPOSICIÓN NATURAL

Neolith utiliza las mejores materias primas; una selección de minerales premium totalmente naturales. Neolith no añade arena de sílice cristalina, cristobalita ni resinas en su composición.

98R

Neolith incorpora hasta un 98% de contenido reciclado en algunos de sus modelos, conservando sus propiedades físicas y estéticas.

RECYCLABLE

Debido a su composición natural, Neolith prolonga su ciclo de uso y puede ser reciclado al final de su vida útil.

SIN CUARZO AÑADIDO

El contenido de sílice libre cristalina de Neolith, en forma de impurezas, se sitúa por debajo del 9%, posicionándose en el rango más bajo del mercado.*

* Consultar ficha técnica de producto

BENEFICIOS SOSTENIBLES ADICIONALES

El proceso de sinterización único de Neolith proporciona beneficios adicionales.

Rehabilitación

Neolith se puede aplicar directamente sobre superficies existentes. De este modo, se ahorra tiempo, costes y se generan menos residuos que deban transportarse y tratarse, reduciendo aún más las emisiones netas de CO₂.

Consumo de energía optimizada

La alta resistencia de Neolith a temperaturas extremas hace que sea ideal para fachadas ventiladas. El aislamiento térmico y ventilación entre la fachada Neolith y el propio edificio optimiza el consumo de energía.

25 años de garantía

Las encimeras y tablas Neolith no necesitan tratamientos de sustitución o mantenimiento frecuentes. Por eso Neolith ofrece una garantía de hasta 25 años en sus encimeras para uso residencial, previo registro y de acuerdo con los términos y condiciones descritos en neolith.com/es/garantia

Certifications and Awards

Certificados y premios

Since its inception in 2009, Neolith has received recognition through more than 50 international design and architecture awards for its forward-thinking, innovative approach and the high quality of its products and processes.

These accolades reflect Neolith's pioneering spirit as a company constantly evolving to meet the needs and expectations of its current and future customers.

Desde su fundación en 2009, Neolith ha recibido el reconocimiento a través de más de 50 premios internacionales de diseño y arquitectura por su enfoque innovador y vanguardista y la alta calidad de sus productos y procesos.

Estos galardones reflejan el espíritu pionero de Neolith, una compañía en constante evolución para satisfacer las necesidades y expectativas de sus clientes actuales y futuros.

CERTIFICATIONS / CERTIFICADOS

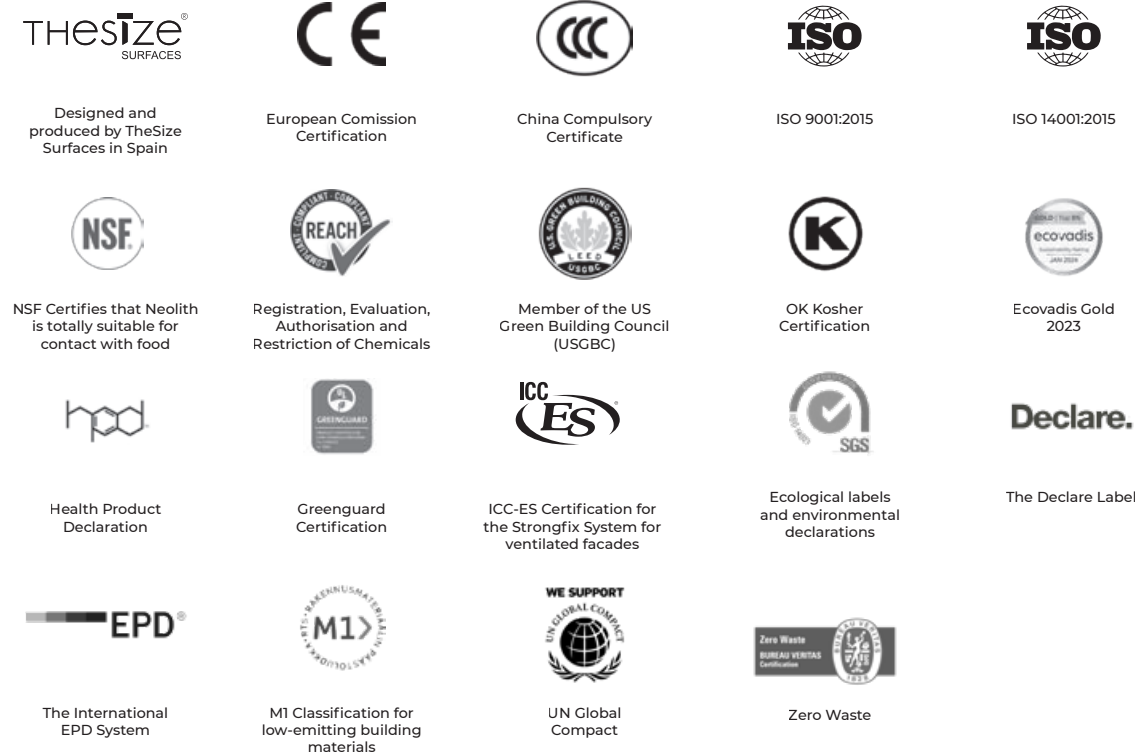

SUSTAINABILITY AND INSTALLATION AWARDS

PREMIOS DE SOSTENIBILIDAD E INSTALACIÓN

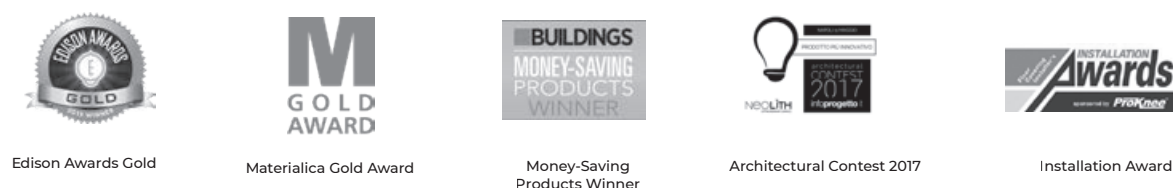

PRODUCT DESIGN AWARDS / PREMIOS DE DISEÑO DE PRODUCTO

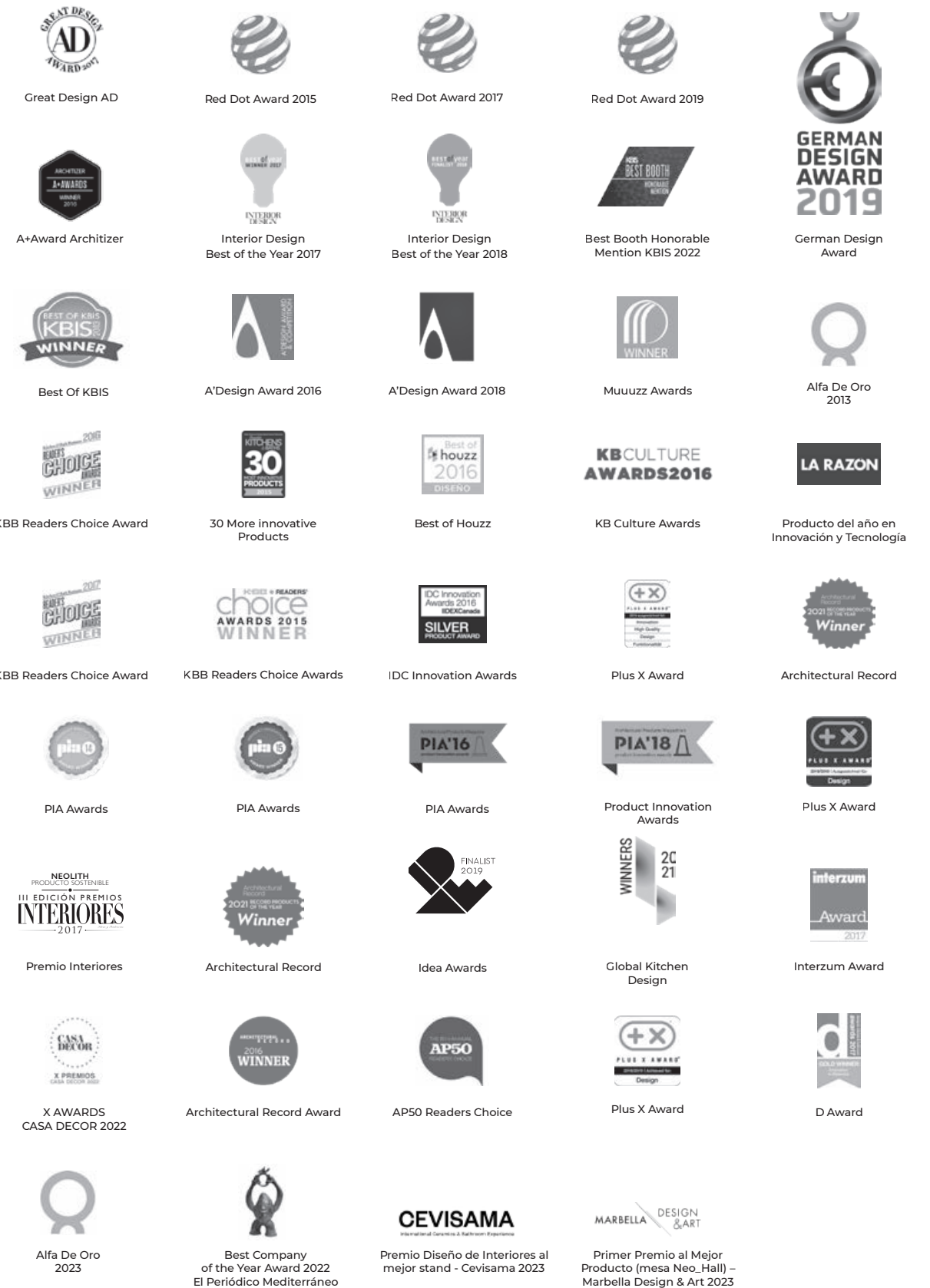

Technical Features

Características Técnicas



NEAR ZERO POROSITY / POROSIDAD CERCANA A CERO

Waterproof and resistant to liquids, with an absorption level of almost zero.
Impermeable y resistente a líquidos, con un nivel de absorción próximo a cero.



SCRATCH RESISTANT * / RESISTENTE AL RAYADO*

Its hard surface makes it resistant to scratches and abrasion.
Resistente al rayado y a la abrasión gracias a la dureza de su superficie.



RESISTANT TO HIGH TEMPERATURES / RESISTENTE A LAS ALTAS TEMPERATURAS

It does not burn in contact with fire nor does it emit smoke or toxic substances when subjected to high temperatures in daily use.
No se quema en contacto con el fuego ni emite humo ni sustancias tóxicas al ser sometido a altas temperaturas en su uso cotidiano.



EASY TO CLEAN / FÁCIL DE LIMPIAR

Neolith's low porosity and lack of joints facilitate hygiene and make it very easy to clean.
La baja porosidad de Neolith, así como la ausencia de juntas, facilitan la higiene y hacen que sea muy fácil de limpiar.



SUITABLE FOR CONTACT WITH FOOD / APTO PARA EL CONTACTO CON ALIMENTOS

It does not release any harmful substances and is totally suitable for contact with food. NSF Certification.
No desprende sustancias nocivas. Es totalmente apto para el contacto con los alimentos. Certificado NSF.

* PLEASE CHECK USE DATASHEET AT NEOLITH.COM

* CONSULTAR LA FICHA DE USO EN NEOLITH.COM



ULTRA-HYGIENIC / ULTRAHIGIÉNICO

Neolith's special composition makes it resistant to most chemical products and it can be disinfected with a wide range of strong household cleaning products.
La composición especial de Neolith, lo hace impermeable a la mayoría de los productos químicos, pudiendo ser desinfectado con una amplia gama de potentes productos limpiadores domésticos.



LIGHTWEIGHT / LIGERO

Lighter than many interior claddings or surfaces, Neolith is available in a variety of thicknesses, including an ultra-thin 3 mm.
Más ligero que muchos revestimientos o superficies interiores, Neolith se puede adquirir en diversos espesores, incluyendo uno ultra-fino de 3 mm.



UV RESISTANCE / RESISTENTE A RAYOS UV

Being 100% natural, its colors do not fade away when exposed to sunlight or other extreme weather conditions.
Siendo 100% natural, los colores no se desvirtúan cuando el material se expone al sol o a condiciones meteorológicas extremas.



RESISTANT TO BENDING / RESISTENTE A LA FLEXIÓN

Its high modulus of rupture makes it resistant to high pressure and heavy loads.
Módulo de rotura elevado. Resistente a altas cargas de presión y peso.

Formats, Applications and Thicknesses

Formatos, aplicaciones y espesores

Neolith is manufactured in large format slabs of around 5 m². This allows the product to adapt to any type of project, reducing joints, making it easier to clean and improving its look. Also, it is quicker to install.

Neolith se fabrica en losas de gran formato de unos 5 m². Esto permite que el producto se adapte a cualquier tipo de proyecto, reduciendo las juntas, aumentando la facilidad de limpieza del producto y mejorando su estética. Además, la instalación es más rápida.

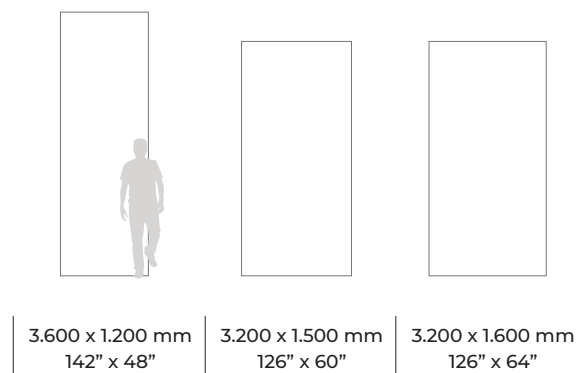

Interior walls Revestimiento interior	3+	6 · 6+	12 · 20
Interior floors Pavimento interior		6 · 6+	12 · 20
Bonded Façade Fachada aplacada exterior	3+	6 · 6+	12 · 20
Exterior floors Pavimento exterior		6 · 6+	12 · 20
Ventilated façade with exposed fixing system Fachada ventilada anclaje visto		6+	12
Ventilated façade with hidden fixing system Fachada ventilada anclaje oculto		6+	12
Worktops Encimeras			12 · 20
Heavy transit floors Pavimento alto tránsito		6+	12 · 20
Interior cladding over existing walls Revestimiento interior sobre material	3+	6 · 6+	
Interior flooring over existing floors Pavimento interior sobre material		6 · 6+	
Furniture Mobiliario	3 · 3+	6 · 6+	12 · 20

● Recommended thicknesses

Cut to size formats also available for projects. Dimensions in inches are Nominal inches.

+ Slab reinforced with fiberglass.

● Espesores recomendados

Formatos de corte a medida también para proyectos.

+ Tabla reforzada con fibra de vidrio.

Neolith offers premium surfaces in four different thicknesses.
Neolith ofrece superficies premium en cuatro espesores diferentes.

Each one a specific range of applications: / Cada uno tiene su propia gama específica de aplicaciones:

3 MM 1/8"	INTERIOR WALL CLADDING, FURNITURE CLADDING REVESTIMIENTOS MUROS INTERIORES, PANELADO DE MUEBLES	6 MM 1/4"	INDOOR / OUTDOOR FLOORING, INTERIOR AND EXTERIOR CLADDING, FURNITURE CLADDING PAVIMENTOS INT./EXT., REVESTIMIENTOS INTERIORES Y EXTERIORES, PANELADO DE MOBILIARIO
12 MM 1/2"	KITCHEN COUNTERTOPS, TABLE TOPS AND BATHROOM VANITIES ENCIMERAS DE COCINA, MESAS Y TOCADORES DE BAÑO	20 MM 3/4"	KITCHEN COUNTERTOPS AND TABLE TOPS ENCIMERAS DE COCINA Y MESAS

STANDARD TILE FORMATS / FORMATOS DE BALDOSAS

Neolith offers premium sintered stone surfaces in standard tile formats.

Neolith ofrece superficies de piedra sinterizada Premium en los formatos estándar de baldosa.

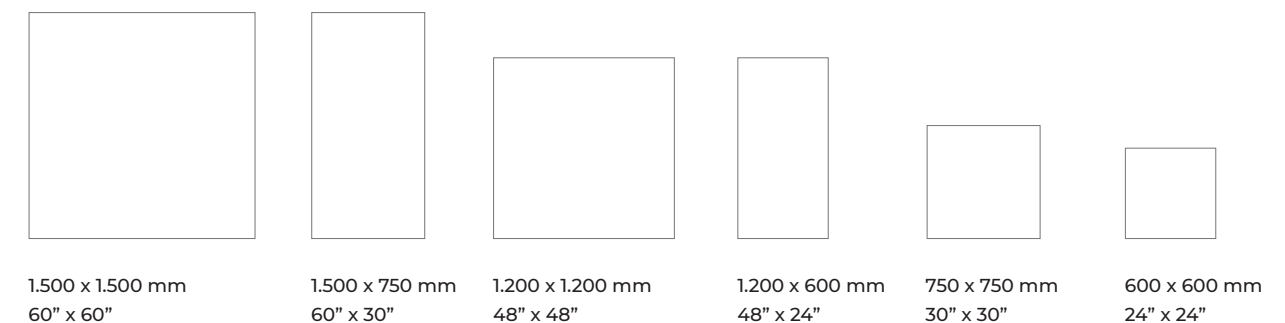

Cut-to-size formats also available for projects. Dimensions in inches are Nominal inches.

Formatos de corte a medida también para proyectos.

Finishes / Acabados

Neolith is available in different finishes that add richness and value to the designs created with these surfaces: from rough textures with relief to shiny polishes with linear reflections.

Neolith está disponible en distintos acabados que aportan riqueza y valor a los diseños creados con estas superficies: desde texturas rugosas con relieve hasta brillantes pulidos con reflejos lineales.

A complete repertory to stimulate the sight and touch.

Todo un repertorio para estimular la vista y el tacto.

MATTE FINISHES / ACABADOS MATE



SATIN

A completely matte finish. Highly resistant and ideal for commercial applications.

Acabado completamente mate. Altamente resistente e ideal para aplicaciones comerciales.



SILK

A matte finish with a thin layer of glaze that provides a subtle shine and a nice soft touch. Finish that results extremely easy to clean.

Acabado mate con una ligera capa de esmalte que aporta un brillo sutil y una agradable suavidad al tacto. Acabado superficial que resulta extremadamente fácil de limpiar.



ULTRASOFT

Matte texture with utmost softness and depth.

Textura mate con el máximo grado de suavidad y profundidad.

GLOSSY FINISHES / ACABADOS BRILLO



DÉCOR POLISHED

The Décor Polished gives a perfectly linear reflection to the colors of the Classtone Collection, which gains in depth and elegance.

Décor Polished confiere un reflejo perfectamente lineal a los colores de la Colección Classtone, que gana en profundidad y elegancia.



NANOTECH POLISHED

With a high level of gloss, the Nanotech Polished lends a more refined look to the Colorfeel Collection.

Con un nivel de brillo alto, Nanotech Polished confiere una imagen más sofisticada a la Colección Colorfeel.

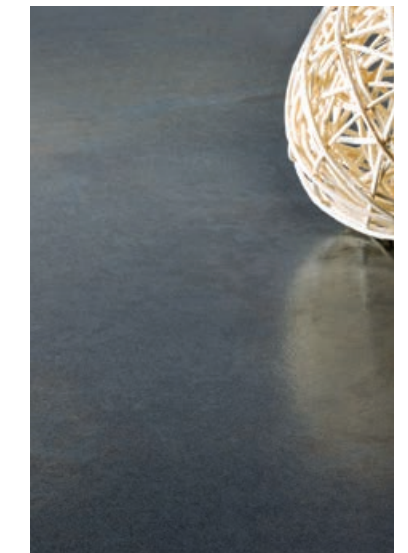

STEEL TOUCH

Steel Touch is Neolith's metallic finish with smooth reflections and surfaces.

El acabado Steel Touch es un enfoque metálico que ofrece Neolith con unos reflejos suaves y superficies

TEXTURED FINISHES / ACABADOS CON TEXTURAS



RIVERWASHED

A finish with a rough texture and high relief for surfaces that evoke sensations to the touch.

Acabado con textura rugosa y alto relieve para superficies que evocan sensaciones al tacto.



SLATE FINISH

Similar to a natural slate, the Slate finish creates the illusion of strata on the surface.

Como una pizarra natural, el acabado Slate crea la ilusión de estratos en la superficie.

Edges / Cantos

Neolith is a product with superior technical features, but requires special care in the manufacturing and finishings of its edges.

The larger the radius, the better it will withstand impacts but also the more the base color of the slab will show through. In areas with a high risk of impact (sinks, for example), a **2 mm radius edge** is recommended; this is the best balance of good looks and durability.

The edges shown here can also be mitered.

Neolith es un producto de características técnicas superiores, pero que requiere de especial atención en la elaboración y acabado de sus cantos.

Cuanto mayor sea el radio, mejor soportará los impactos pero también se mostrará más el color base de la tabla.

En áreas con un alto riesgo de impacto (por ejemplo fregaderos) se recomienda los **2 mm de canto del radio**; siendo esta la mejor opción entre estética y durabilidad.

Los cantos retratados aquí, también pueden aplicarse a inglete.

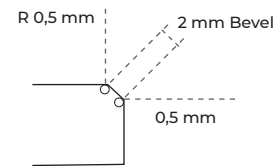

STANDARD EASED EDGE
CANTO SENCILLO

Only for squares and rectangles
Solo en cuadrados y rectángulos



MITERED EDGE
CANTO A INGLETE



HALF-BULLNOSE EDGE
CANTO SEMI-REDONDO
6 MM

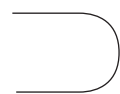

FULL BULLNOSE EDGE
CANTO REDONDO
6 MM



HALF-BULLNOSE EDGE
CANTO SEMI-REDONDO
12/20 MM



EASED EDGE TOP AND BOTTOM
CANTO SENCILLO DOBLE

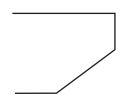

BEVELED BOTTOM EDGE
CANTO BISELADO INFERIOR

Only for squares and rectangles
Solo en cuadrados y rectángulos

25-Year warranty Garantía 25 años

Neolith offers a 25-year warranty on its 12 and 20 mm thick slabs used to manufacture residential countertops, as well as on its 6 and 12 mm thick slabs used for backsplashes. For warranty registration, please use the link in the QR code on this page. To register, you need to know the barcode of your Neolith slab. Consult your installer or kitchen store if you do not know it.

In order to receive warranty services, you must have registered your warranty on the warranty.neolith.com website within 60 calendar days from the date of purchase indicated on your receipt.

You must complete all fields marked with an asterisk (*) and submit a purchase receipt or other acceptable type of documentary proof of purchase that clearly shows the date of purchase.

Neolith ofrece una garantía de 25 años en sus tablas de espesores 12 y 20 mm utilizadas para la fabricación de encimeras residenciales. También ofrece garantía para las tablas Neolith de espesores 6 y 12 mm utilizadas para el salpicadero.

Para el registro de la garantía, utiliza el enlace situado en el código QR de esta página. Para realizar el registro es necesario conocer el código de barras de tu tabla de Neolith. Consulta con tu instalador o tienda de cocina si no lo conoces.

Para que se te puedan prestar los servicios derivados de la garantía, deberás haber hecho el registro de la garantía en la página web warranty.neolith.com en un plazo máximo de 60 días naturales desde la fecha de compra indicada en la factura.

Será necesario rellenar todos los campos marcados con un asterisco (*) y presentar un recibo de compra u otro tipo de justificación documental aceptable de la compra en la que conste claramente la fecha de la misma.



Register your warranty



Registra tu garantía

Cleaning and Maintenance Limpieza y Mantenimiento

POLISHED AND ULTRASOFT FINISHES

Neolith Polished and Ultrasoft finishes stand out for their esthetic features. To achieve such degree of gloss and texture, the finest raw materials and the most cutting-edge technology have been used in their production. Unlike the other Neolith matte finishes (Satin, Riverwashed, Silk and Slate), special care must be taken when using certain chemical products on the countertop or regarding its resistance to scratches.

CLEANING PRODUCTS	
SUITABLE	NOT SUITABLE
Degreasers	Cleaners and abrasive sponges
Ammonia	Bleach
Solvents	Ferrokít
Alcohol	Hydrofluoric acid
Acetone	Scrub cleaning creams
-	Alkalis (potash, soda)

* To clean a Polished countertop, we recommend using soapy water and a damp cloth. If there are encrusted/dry stains, soak the stain with a suitable detergent and wait to rub with a damp cloth.

NEVER USE: FERROKIT, an iron oxide stain remover for fabrics that contains, among other ingredients, hydrofluoric acid, WHICH CAN DAMAGE COUNTERTOPS, and alkalis such as potash and soda.

* Special care with ceramic knives: Ceramic knives may scratch the Neolith surface in every finish, the same way they scratch other brands in the same product category and other categories.

NEOLITH POLISHED FINISH APPLICATIONS	
SUITABLE	NOT SUITABLE
Countertop	Outdoor flooring (abrasion by dust)
Interior and exterior cladding	Interior flooring with medium or high traffic (slippery, abrasion by transit) Bathroom and wet areas flooring
Interior flooring with exclusively pedestrian traffic of low intensity, not connected to the outside	Sinks (impacts, chafing)

ACABADOS PULIDOS Y ULTRASOFT

Las superficies Neolith acabado Pulido y Ultrasoft destacan por sus características estéticas. Para lograr este nivel de brillo y textura, se han utilizado en su producción las materias primas de mayor calidad y la tecnología más avanzada. Al contrario que con los otros acabados mate Neolith (Satin, Silk, Riverwashed y Slate), hay que tener en cuenta consideraciones especiales a la hora de usar algunos productos químicos sobre la encimera o acerca de su resistencia al rayado.

PRODUCTOS DE LIMPIEZA	
APTO	NO APTO
Desengrasantes	Limpiadores y esponjas abrasivas
Amoniaco	Lejía
Disolventes	Ferrokít
Alcohol	Ácido hidrófluórico
Acetona	Limpiadores de vitrocerámica
-	Alcalinos (potasa, sosa)

* Para la limpieza de una encimera pulida, se recomienda utilizar agua con jabón y una bayeta húmeda. Si hay manchas incrustadas/secas, hay que empapar la mancha con el detergente adecuado y esperar para frotar con una bayeta húmeda.

NO UTILIZAR NUNCA: FERROKIT, un quitamanchas de óxido de hierro para tejidos que contiene entre otros compuestos, ácido fluorhídrico que DAÑA LAS ENCIMERAS ni alcalinos como la potasa y la sosa.

* Consideración especial con los cuchillos cerámicos: Los cuchillos de cerámica pueden rayar la superficie de Neolith en todos los acabados, de la misma forma que rayan otras marcas de la misma categoría de producto y otras categorías.

APLICACIONES DE NEOLITH ACABADO PULIDO	
APTO	NO APTO
Encimera	Pavimento exterior (Abrasión por polvo)
Revestimiento interior, exterior	Pavimento interior con tránsito medio o alto. (Resbaladizo, abrasión por tránsito) Pavimento de baños y zonas húmedas
Pavimento interior de una vivienda con tránsito exclusivamente peatonal de intensidad baja, no comunicado con el exterior	Fregaderos (Impactos, Rozaduras)

Satin, Silk, Riverwashed and Slate finishes / acabados

Neolith countertops are easy to clean since food debris and residues cannot penetrate the material, thus guaranteeing good hygiene. In most cases, only a damp cloth is needed for cleaning.

Stains created by food and substances generally used in kitchens (e.g. lemon juice, vinegar, olive oil, wine and coffee) are easy to remove.

Even highly aggressive cleaning agents (such as oven cleaners) do not affect the Neolith surface.

Here are some of the substances recommended for removing stains:

Las encimeras Neolith tienen una limpieza fácil, ya que los restos de comida y residuos que se depositen, no pueden penetrar en el material, por lo que garantizan una buena higiene. Para la mayoría de los casos, sólo bastará con un paño húmedo para limpiarla.

Las manchas creadas por alimentos y sustancias generalmente usados en las cocinas (por ejemplo zumo de limón, vinagre, aceite de oliva, vino o café), son fáciles de eliminar.

Incluso los agentes de limpieza altamente agresivos (como limpiadores de horno), no afectan a la superficie Neolith.

A continuación, se indican algunas de las sustancias indicadas para eliminar las manchas:

APPLICATIONS FOR NEOLITH SATIN, SILK, RIVERWASHED AND SLATE FINISHES		
TYPES OF STAINS / TIPOS DE MANCHAS	CHEMICAL PRODUCT / PRODUCTO QUÍMICO	COMMON EXAMPLES / EJEMPLOS COMUNES
Grease / Grasas	Alkaline - Solvent / Alcalino - Solvente	Detergent / Detergente
Oil / Aceite	Solvent / Solvente	Ammonia / Amoniaco
Ink / Tinta	Oxidant - Solvent / Oxidante - Solvente	Alcohol or acetone / Alcohol o acetona
Rust / Óxido, herrumbre	Acid / Ácido	Hydrochloric acid and descaling products / Sulfumán y desincrustantes
Lime / Cal	Acid / Ácido - Antical / Antical	Descaling products / Desincrustantes
Cement / Cemento	Acid / Ácido	Hydrochloric acid, oxygenated water and descaling products / Sulfumán, agua oxigenada y desincrustantes
Wine / Vino	Alkaline / Alcalino	Ammonia or bleach / Amoniaco o lejía
Coffee / Café	Alkaline - Solvent / Alcalino - Solvente	Ammonia or bleach / Amoniaco o lejía
Plaster / Yeso	Acid / Ácido	Hydrochloric acid and descaling products / Sulfumán y desincrustantes
Candle wax / Cera de velas	Solvent / Solvente	Alcohol or acetone / Alcohol o acetona
Iodine / Yodo	Oxidant / Oxidante	Bleach / Lejía
Blood / Sangre	Oxidant / Oxidante	Bleach, oxygenated water / Lejía, agua oxigenada
Ice cream / Helado	Alkaline / Alcalino	Detergent / Detergente
Resins / Resinas	Solvent / Solvente	Alcohol or acetone / Alcohol o acetona
Fruit juice / Jugo de frutas	Oxidant / Oxidante	Bleach / Lejía
Aluminum scratches / Viruta de aluminio	Acid / Ácido	Hydrochloric acid and descaling products / Sulfumán y desincrustantes

“Beyond a gastronomy experience”
“Más allá de una experiencia gastronómica”

NEOLITH KITCHEN Collection

Unleashing your imagination is easier with a material that is made to last. A sustainable material that lets you enjoy every moment.

Neolith brings added value to the dining experience, providing a tool to inspire unique, elegant, functional and sustainable solutions.

Innovation, quality, design and functionality are the attributes pursued by the most demanding chefs when creating their workspaces, and Neolith has proven to be the perfect ally in the world's most renowned haute cuisine restaurants.

Elevate your kitchen and take your creations one step further.

Dar rienda suelta a la imaginación es más fácil con un material que está hecho para durar. Un material sostenible que te invita a disfrutar de cada momento.

Neolith aporta valor añadido a la experiencia gastronómica, proporcionando una herramienta para inspirar soluciones únicas, elegantes, funcionales y sostenibles.

Innovación, calidad, diseño y funcionalidad son los atributos que persiguen los chefs más exigentes de la gastronomía para la creación de sus espacios de trabajo, y Neolith ha demostrado ser el aliado perfecto en los restaurantes más prestigiosos de la alta cocina a nivel mundial.

Eleva tu cocina y lleva tus creaciones un paso más allá.

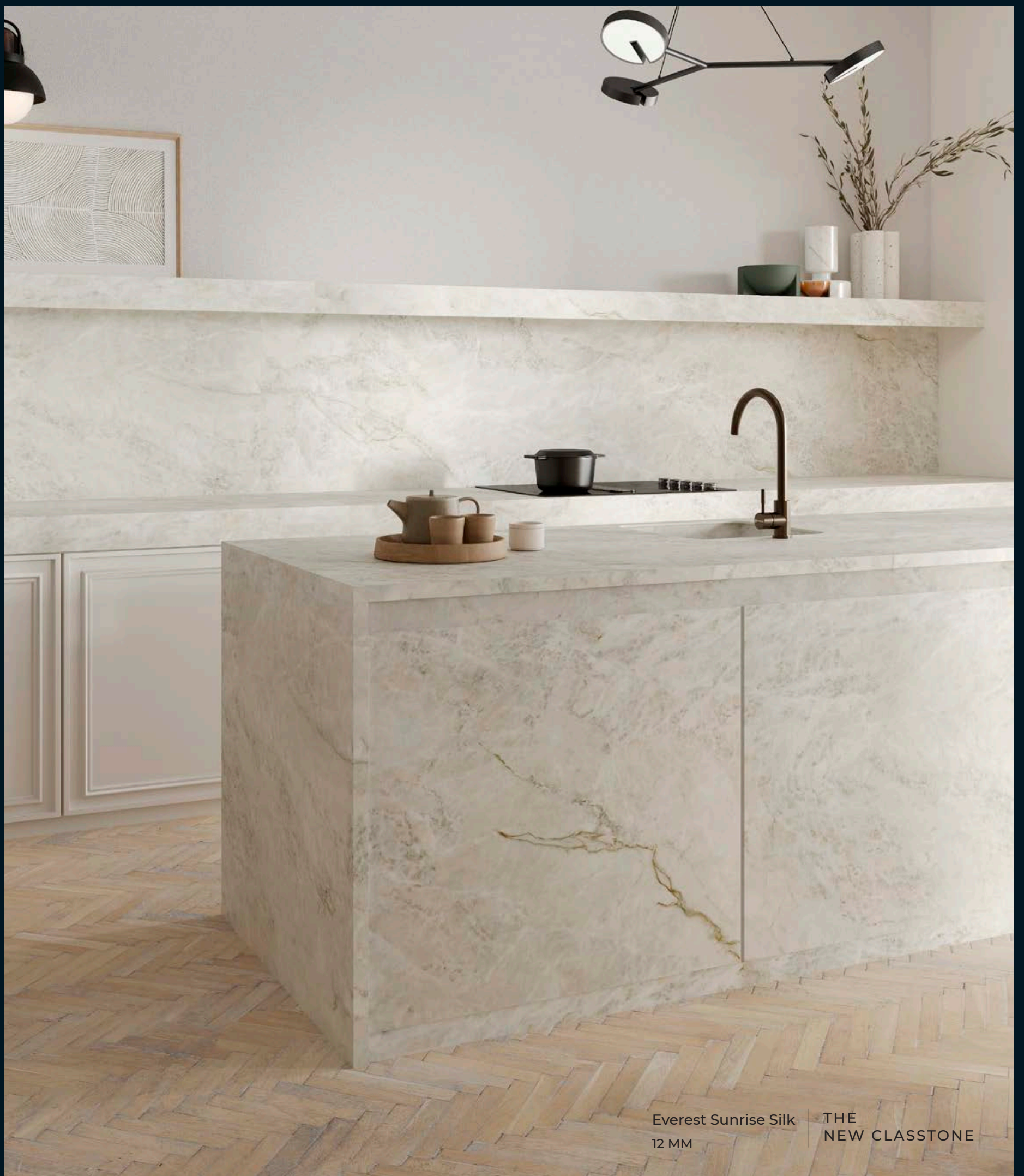

Everest Sunrise Silk
12 MM

THE
NEW CLASSTONE

Neolith: Ultra-hygienic Surfaces

Neolith, superficies ultra higiénicas

Neolith architectural surfaces stand out for their superior technical properties over other types of surfaces.

Thanks to their natural composition and manufacturing process, they do not require special maintenance.

They are resistant to wear and stains, so they can be disinfected with a wide range of strong household cleaning products, such as bleach, alcohol or other disinfectants safe for domestic use.

Neolith's low porosity improves the hygiene of its surfaces, making them waterproof, liquid-resistant and ultra-sanitary.

Neolith is available in large formats, which also minimizes the number of joints in the countertops, thereby considerably reducing the appearance of potentially harmful microorganisms.

Las superficies arquitectónicas Neolith destacan por sus propiedades técnicas superiores frente a otros tipos de superficie.

Gracias a su composición natural y su proceso de fabricación, no requieren de un mantenimiento especial. Son resistentes al desgaste y a las manchas, por lo que pueden ser desinfectadas con una amplia gama de potentes productos limpiadores domésticos, como lejía, alcohol u otros productos desinfectantes seguros para uso doméstico.

La baja porosidad de Neolith facilita la higiene de sus superficies, convirtiéndolas en un producto impermeable, resistente a líquidos y ultra higiénico.

Neolith está disponible en gran formato, lo que permite, además, minimizar el número de juntas de la encimera, reduciendo considerablemente la aparición de microorganismos potencialmente dañinos.

CLEANING TIPS FOR A NEOLITH COUNTERTOP RECOMENDACIONES DE LIMPIEZA EN LA ENCIMERA NEOLITH

01

Clean with lukewarm water and the recommended cleaning product.

Limpiar con agua templada y limpiador recomendado.

02

Leave the cleaning product to work.

Dejar actuar al limpiador.

03

Rinse with water and dry it.

Aclarar con agua y secar.

Calacatta Royale Decor Polished
12 MM

THE
NEW CLASSTONE

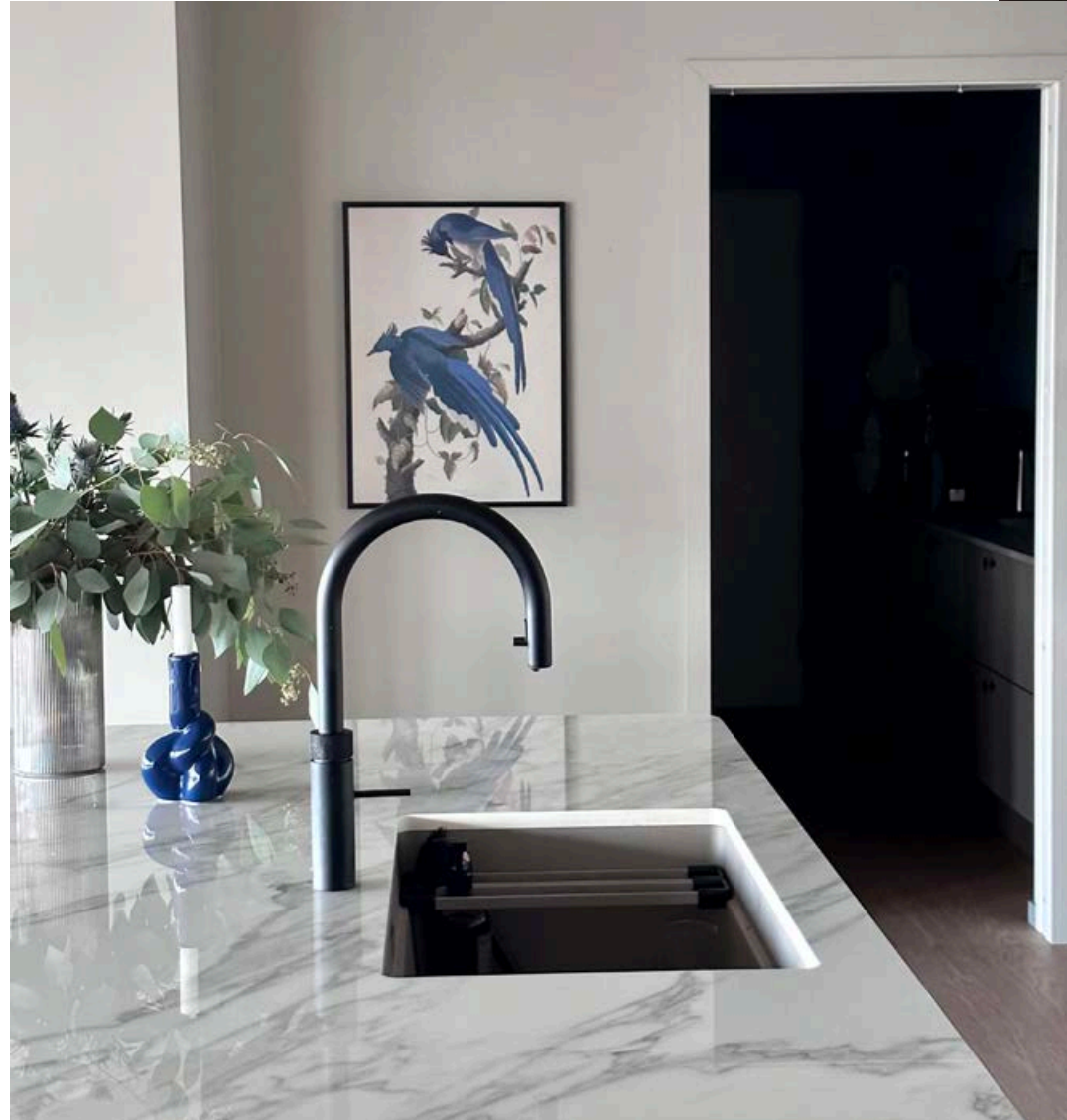

PRIVATE RESIDENCE
Oslo, (Norway)

Distributed: Scan Granitt



KITCHEN

Calacatta Luxe Ultrasoft
12 MM

THE
NEW CLASSTONE



PRIVATE RESIDENCE
Bogotá, (Colombia)

Design: Cuocolab
Stonemason: Volterra Stone
Distributed: Vianova SAS
Image: Carlos Vélez

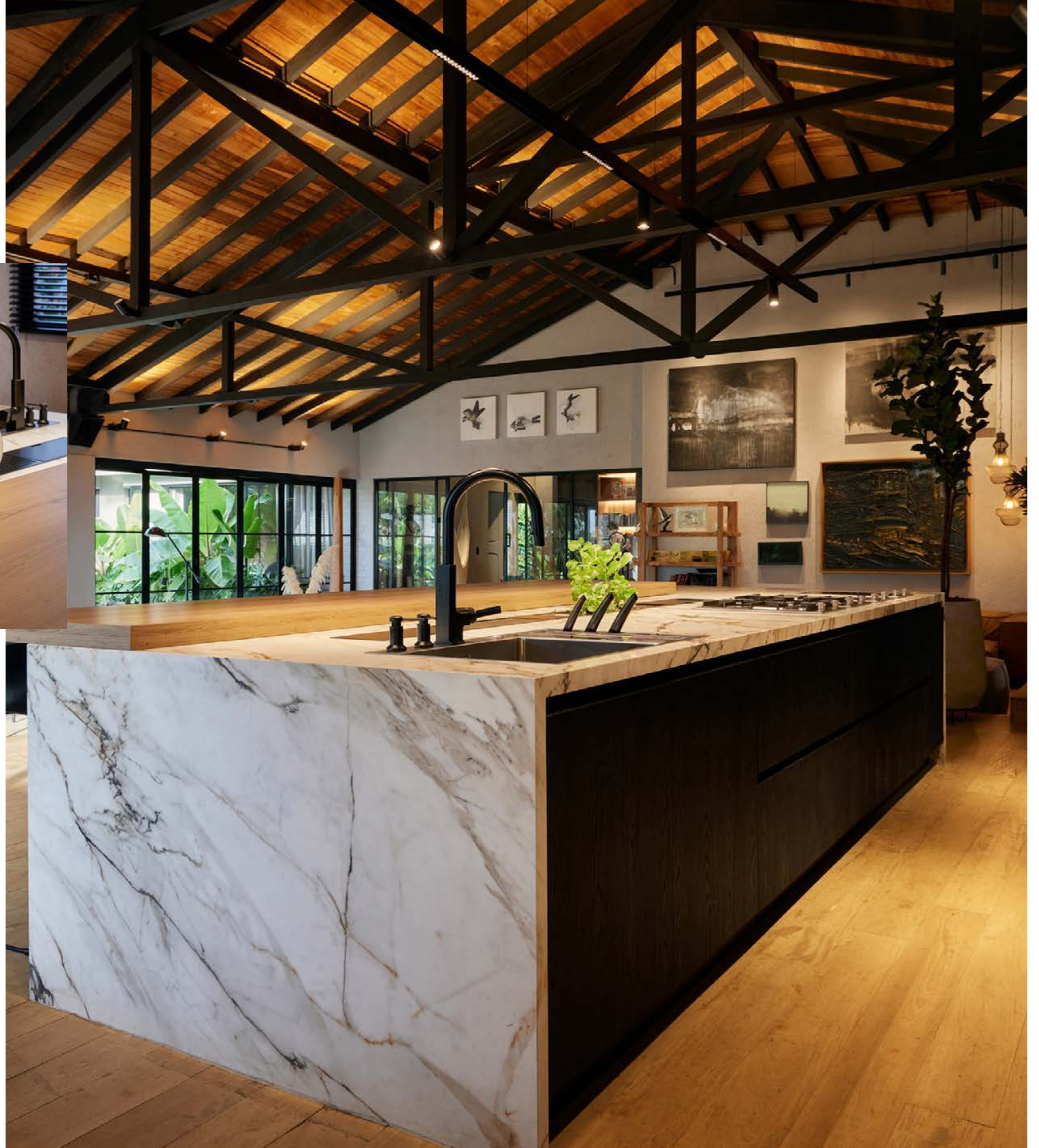

KITCHEN

Mont Blanc Silk
12 MM

THE
NEW CLASSTONE

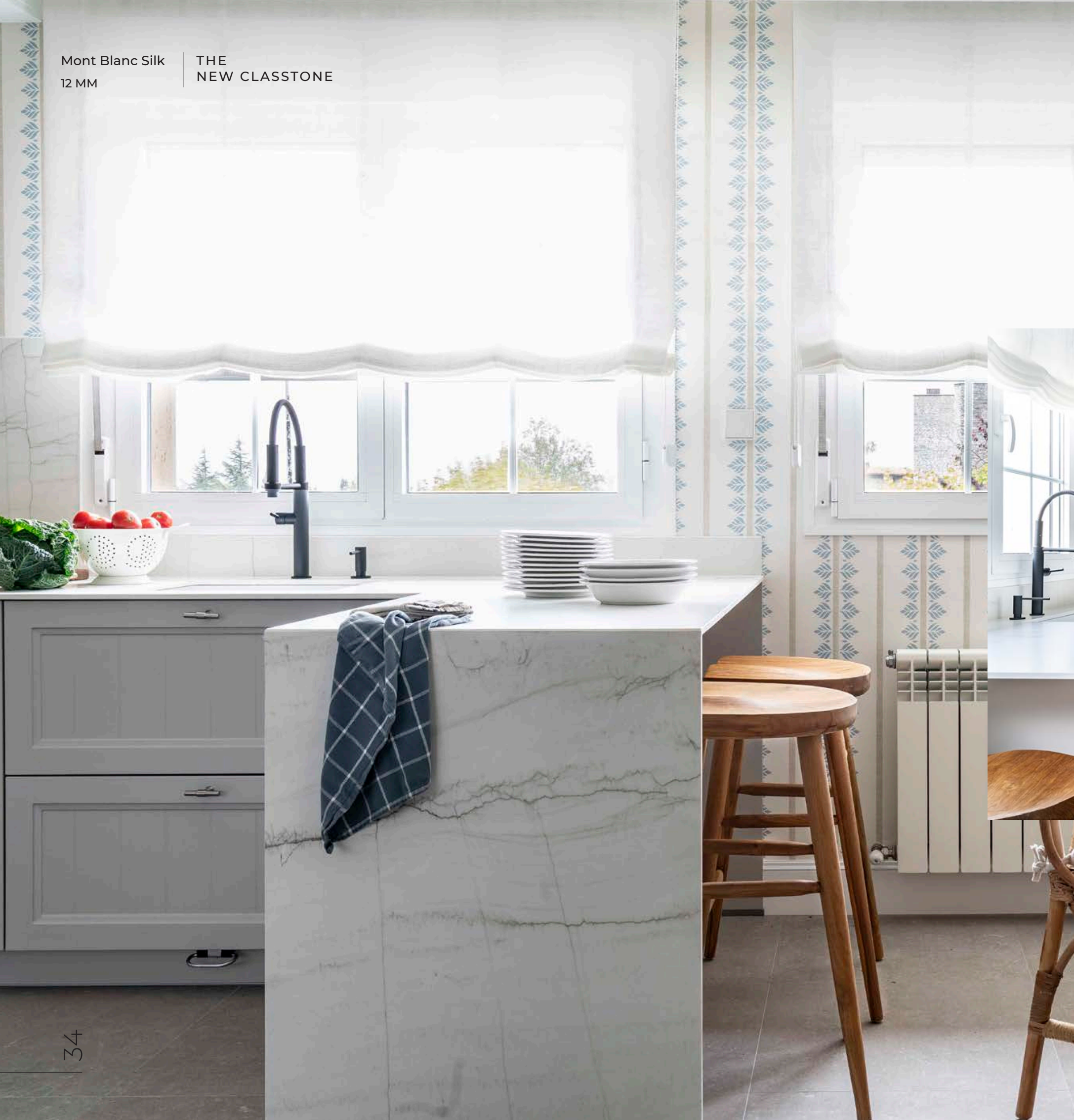

PRIVATE RESIDENCE
Bilbao, (España)

Design: Raquel Gonzalez Interiorismo
Furniture and kitchen Design: Schmidt Norte
Styling: Cristina Rodriguez Goitia
Image: David Montero

Calacatta Royale
Décor Polished
12 MM

THE
NEW CLASSTONE



KITCHEN

PRIVATE RESIDENCE
Melbourne, (Australia)

Design: Lowe Design Build
Image: Dave Kulesza



PRIVATE RESIDENCE
Auckland, (New Zealand)

Design: Modi Design
Fabricator: AGB Stone
Image: Hazel Redmond

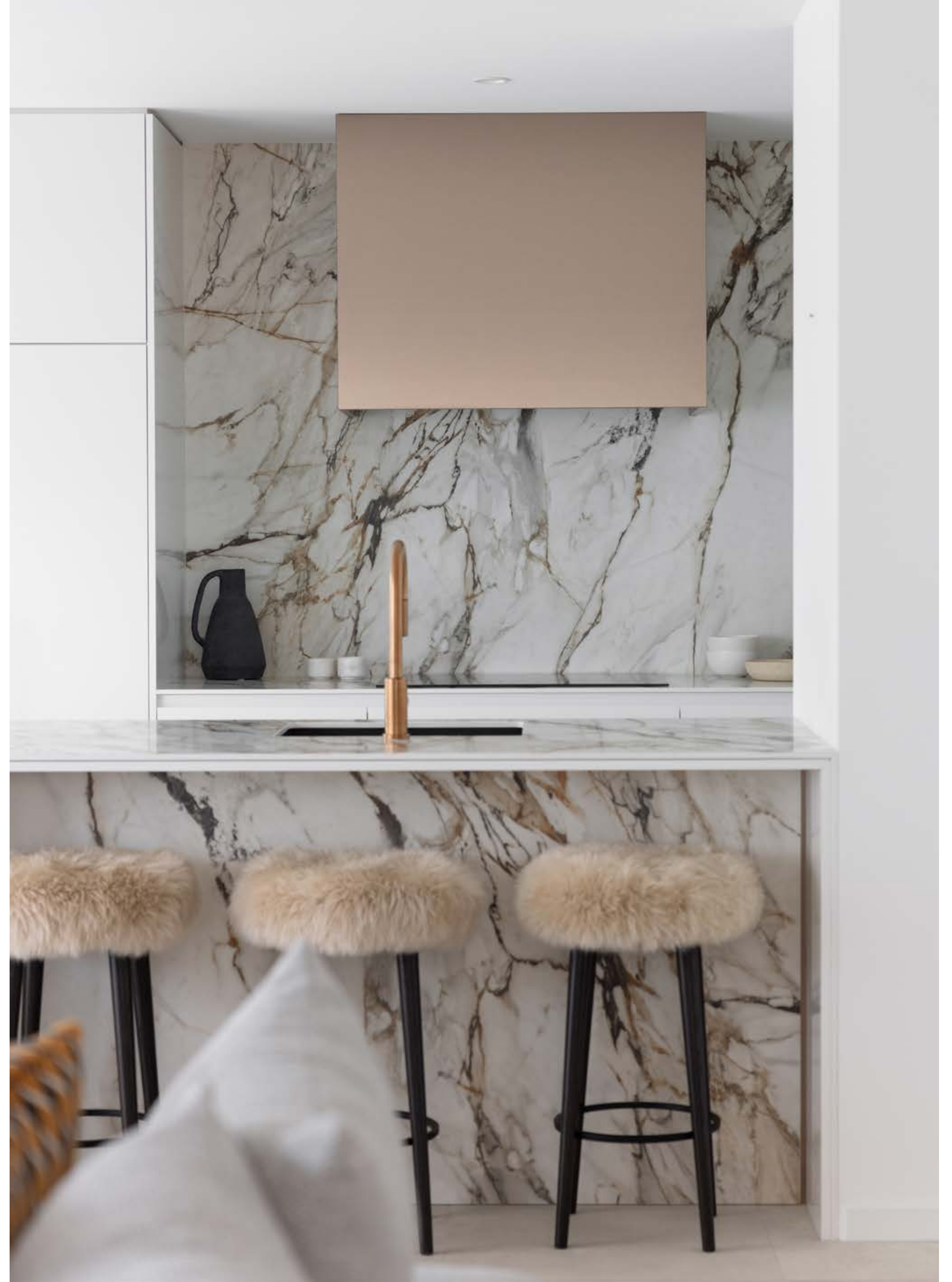

Himalaya Crystal Ultrasoft
12 MM

THE
NEW CLASSTONE



KITCHEN

TERRA COCINAS
Madrid, (Spain)

Design: Devesa & Ajenjo Interiorismo

Himalaya Crystal
Décor Polished
20 MM

THE
NEW CLASSTONE



PRIVATE RESIDENCE
Oslo, (Norway)

Design: Emilie Willoch Frøyland
Distributed: Scan Granitt

KITCHEN

Calacatta Roma Silk
20 MM

THE
NEW CLASSTONE



KITCHEN



PRIVATE RESIDENCE
Oslo, (Norway)

Design: Emilie Willoch Frøyland
Distributed: Scan Granitt

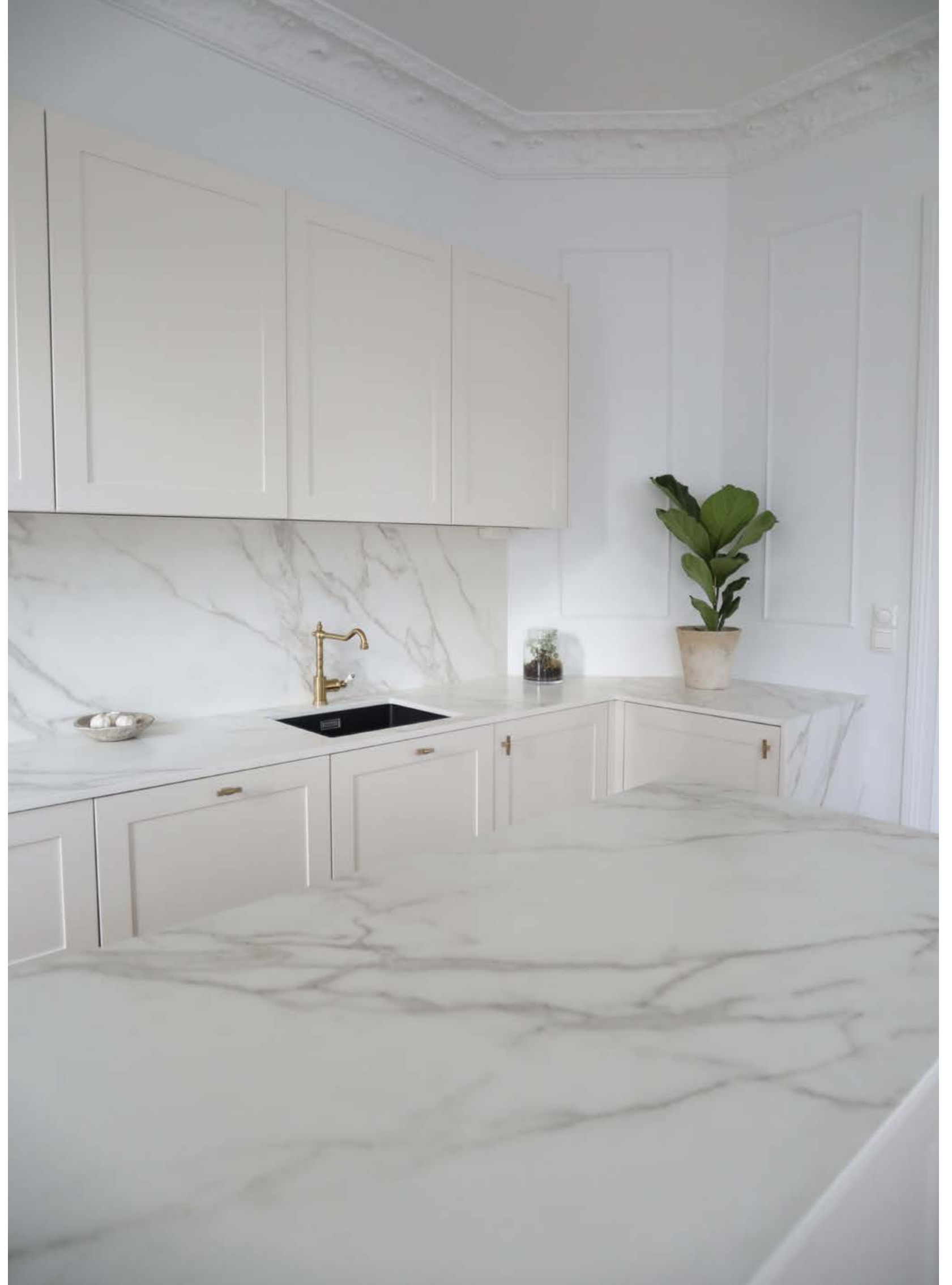

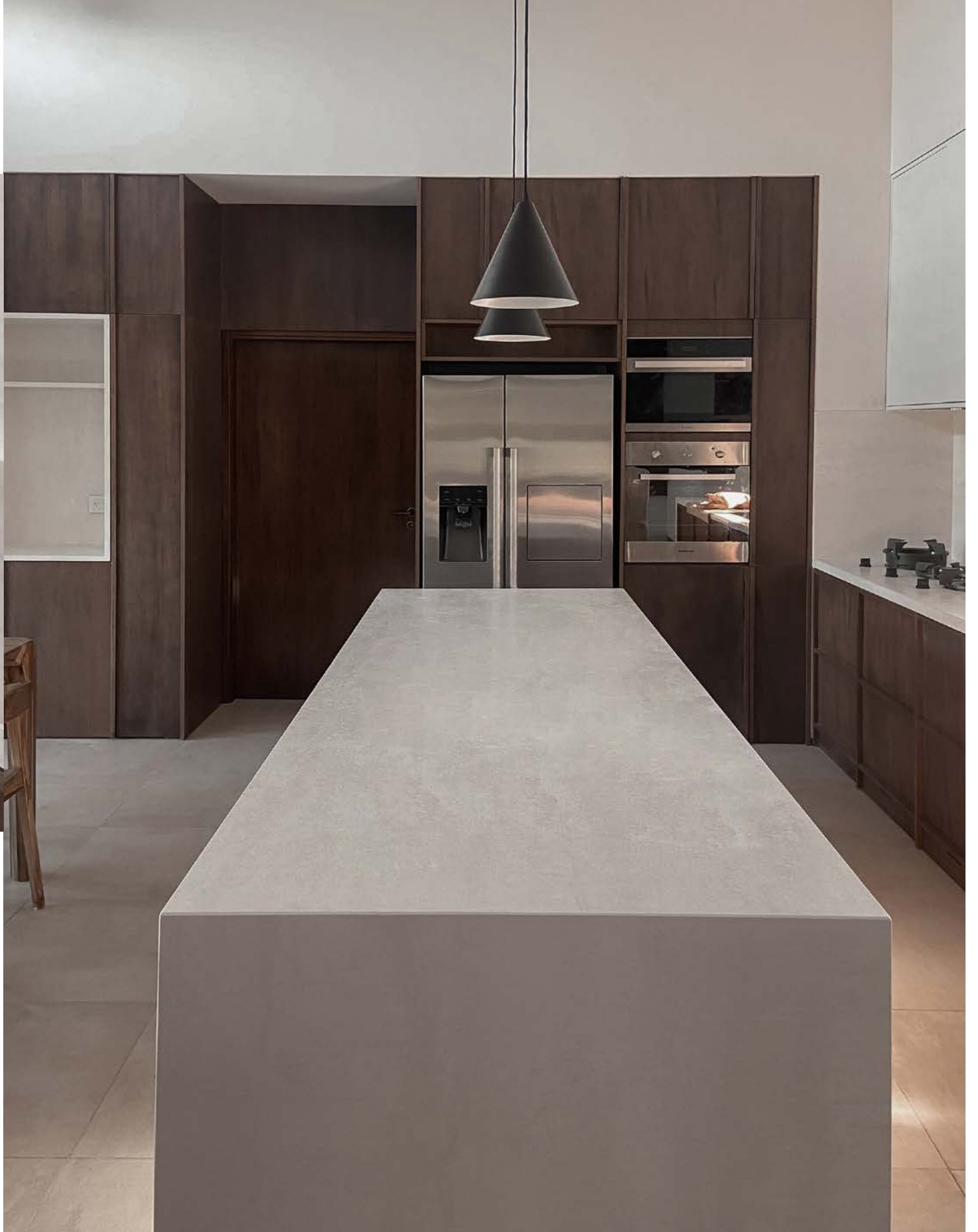

PRIVATE RESIDENCE
Rosario, (Argentina)

Design: Estudio AND
Distributed: De Stefano 1913

Calacatta Gold Ultrasoft
12 MM

THE
NEW CLASSTONE



KITCHEN

PRIVATE RESIDENCE
Auckland, (New Zealand)

Design: Mooi Design
Architecture: Barry Connor Design
Image: Hazel Redmond

Amazonico Slate
12 MM

THE
NEW CLASSTONE



PRIVATE RESIDENCE
Auckland, (New Zealand)

Design: Rare Birds Interiors
Image: Kelsie Barley Photography



FUEGOS 999
Buenos Aires, (Argentina)

Distributed: De Stefano 1913

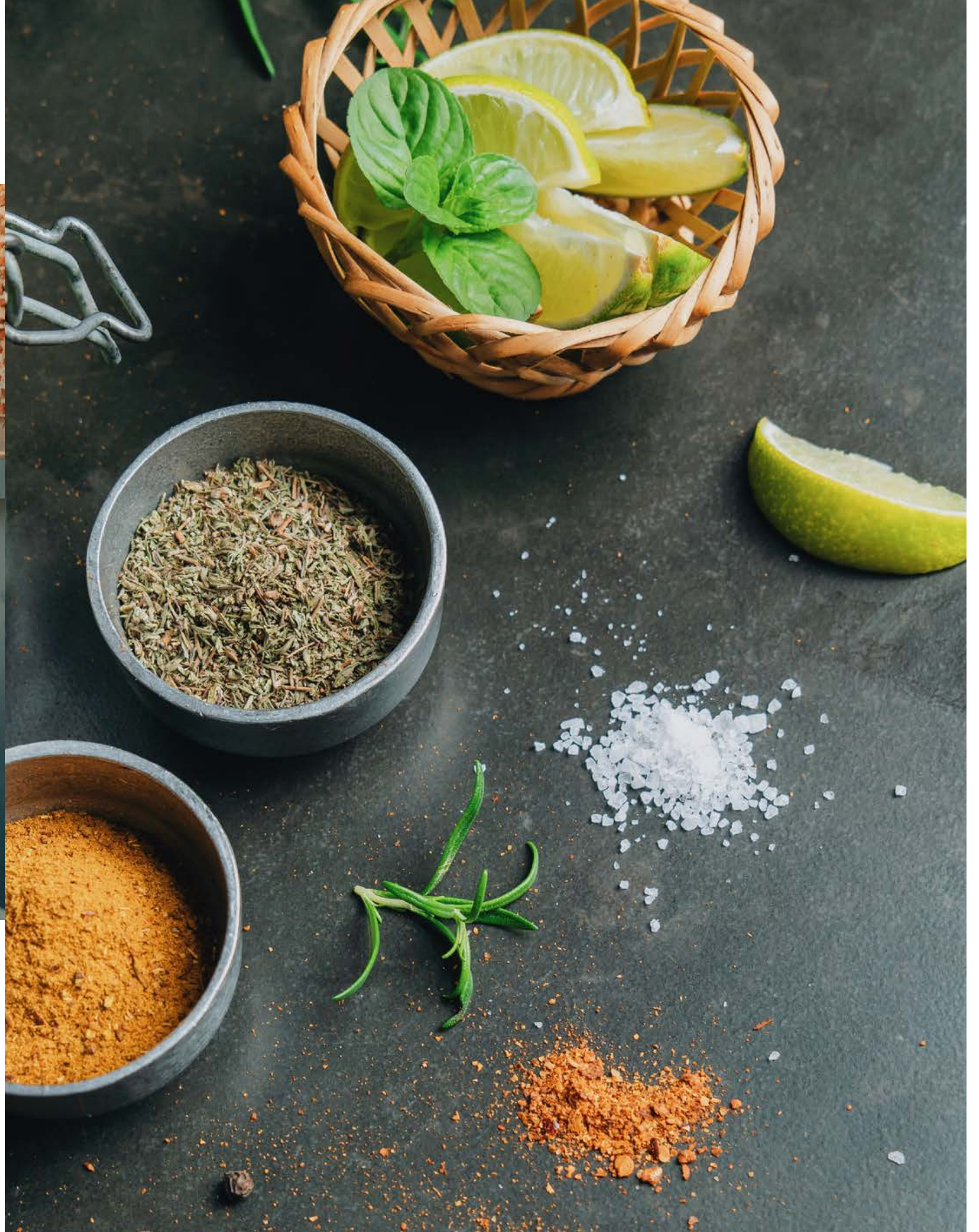



PRIVATE RESIDENCE
Queensland, (Australia)

Design: Alisa & Lysandra



PRIVATE RESIDENCE
Gdynia, (Poland)

Design: PURA Design
Image: LOKUM STUDIO



PRIVATE RESIDENCE
Budapest, (Hungary)

Design: *ness Design Studio
Image: Anna Beketova





WA RESIDENCE
Kota Baru Parahyangan, (Indonesia)

Interior Design: INERRE Interior
Architecture: Pranala Associates





PRIVATE RESIDENCE
Andorra La Vella, (Andorra)
Image: Amparito Sebastiá



PRIVATE RESIDENCE
Rustenburg, (South Africa)

Design: Theo Bothma Architects & Design



PRIVATE RESIDENCE
Milan, (Italy)

Distributed: Stosa S.p.A.
Image: Studio ROSSI&Co

Cappadocia Sunset Silk | FUSION
12 MM



KITCHEN

Beton Silk
12 MM

FUSION



PRIVATE RESIDENCE
Wiltshire, (UK)

Design: Ben Argent Kitchens
Image: Nicholas Yarsley

KITCHEN



PRIVATE RESIDENCE
Wiltshire, (UK)

Design: Ben Argent Kitchens
Image: Nicholas Yarsley

Pietra di Luna Silk
12 MM

FUSION



PRIVATE RESIDENCE
Madrid, (Spain)

Design: Devesa & Ajenjo Interiorismo

Pietra Grey Silk
12 MM

FUSION



KITCHEN

SALONE DEL MOBILE
Milan, (Italy)

Design: Scandola
Image: Inma Mariscal



PRIVATE RESIDENCE
Auckland, (New Zealand)

Design: DuBois Design
Stonemason: GFL Ltd
Image: Michelle Weir



Blanco Carrara Silk
12 MM

THE
NEW CLASSTONE



PRIVATE RESIDENCE
Bilbao, (Spain)

Design: Arantza Ardanza e Iker Pérez
Build: Santos Estudio
Image: Pablo López Abalos

Blanco Carrara Silk
12 MM

THE
NEW CLASSTONE



PRIVATE RESIDENCE
Oslo, (Norway)

Distributed: Scan Granitt



KITCHEN

Just White Silk
12 MM

COLORFEEL



KITCHEN

PRIVATE RESIDENCE
Sydney, (Australia)

Design: Concepts by Gavin Hepper
Image: mm creative co.

Arctic White Satin
12 MM

COLORFEEL

PRIVATE RESIDENCE
Bristol, (UK)

Design: MOON BUILD
Image: Katie Jane Watson



KITCHEN



PRIVATE RESIDENCE
Buenos Aires, (Argentina)

Design: Modulus
Distributed: De Stefano 1913

Nero Zimbabwe
Riverwashed

FUSION

12 MM



PRIVATE RESIDENCE
Park City, (USA)

Design: Kate Lester
Image: Amy Bartlam

Nero Satin | COLORFEEL
12 MM



KITCHEN

PRIVATE RESIDENCE
Medellín, (Colombia)

Design: Era Arquitectura y la Casa Ideal
Image: Carlos Vélez Photo



PRIVATE RESIDENCE
Madrid, (Spain)
Design: José Lara Interiorismo
Stonemason: Mármoles Alcardeteños

Iron Grey Satin | IRON
12 MM



KITCHEN

PRIVATE RESIDENCE
Auckland, (New Zealand)

Design: Kirsty Davis Kitchen Design
Image: Anthony Turnham Photography



CASA PORTORO
São Paulo, (Brazil)

Design: Laura Bela y Henrique Freneda
Image: Marco Pinto

Basat Black Satin
12 MM

FUSION

KITCHEN

PRIVATE RESIDENCE
Milan, (Italy)

Distributed: Stosa S.p.A.
Image: Studio ROSSI&Co

Neolith Gourmet

If they have chosen it, why don't you?
Si ellos lo han elegido, ¿a qué esperas?

Professionals around the world are increasingly choosing Neolith for their dream kitchens, as it represents a material with no compromises: beauty and performance. Choose it all.

Profesionales de todo el mundo eligen cada vez más Neolith para sus cocinas soñadas, ya que representa un material sin concesiones: belleza y rendimiento. Elige todo.

SPAIN



Jordi Cruz
ABAC, Barcelona
🌟🌟🌟 MICHELIN 2022
ATEMPO, Barcelona
🌟 MICHELIN 2022



Mateu Casañas, Oriol Castro y Eduard Xatruch,
DISFRUTAR, Barcelona
🌟🌟 MICHELIN 2022



Hermanos Roca,
EL CELLER DE CAN ROCA,
Girona
🌟🌟🌟 MICHELIN 2022



Eneko Atxa,
AZURMENDI, Larrabetzu
🌟🌟🌟 MICHELIN 2022



Paco Perez,
MIRAMAR, Llançà, Girona
🌟 MICHELIN 2022



Albert Adrià,
ENIGMA, Valencia
🌟 MICHELIN 2021



Begoña Rodrigo,
LA SALITA, Valencia
🌟 MICHELIN 2022



Jordi Artal,
CINC SENTITS, Barcelona
🌟🌟 MICHELIN 2022



QUIQUE DACOSTA
RESTAURANT, Denia
🌟🌟🌟 MICHELIN 2022



Artur Martínez,
AÛRT, Barcelona
🌟 MICHELIN 2022



Albert Raurich
DOS PALILLOS, Barcelona
🌟 MICHELIN 2022



Quim Casellas
CASAMAR, Llafranc, Girona
🌟 MICHELIN 2022



Rafa Zafrá
ESTIMAR, Barcelona
🌟 MICHELIN 2022



Paco Torreblanca,
Escuela Torreblanca,
Petrer, Alicante



Germán Carrizo
Fierro
🌟 MICHELIN 2022



Fabian León
MasterChef



GASMA, Castellón



CONTACTO COCINA,
Madrid

REST OF EUROPE



Juan Amador,
AMADOR WIRTSHAUS &
GREISLEREI, Viena, AT
🌟🌟 MICHELIN 2022



Jean Pierre Pastor
MELTEMI, Parma, IT
MICHELIN 2022



Italo Bassi,
CONFUSION, Porto Cervo, IT
🌟 MICHELIN 2022



Sebastian Frank,
Horváth, Berlin, GE
🌟🌟 MICHELIN 2022



Hans van Wolde
BELUGA LOVES YOU,
Maastricht, NE
🌟 MICHELIN 2022



Marco Parizzi
PARIZZI, Parma, IT
🌟 MICHELIN 2022



Jan Marrees
MARREES, Weert, NL
🌟 MICHELIN 2022



Cédric Grolet,
Paris, FR



Pierre Sang,
Paris, FR



Sonia Peronaci
IL CANTIERE, Milan, IT



Kevin Thornton,
Dublin, IE



THE KITCHEN
AT CHEWTON GLEN,
New Milton, UK



Herman den Blijker
GOUD, Rotterdam, NL



Anne Sophie
FASHION COOKING,
Paris, FR



Alessandro
Borghese, LUSSO DELLA
SEMPLICITÀ, Milan, IT



Rich Harris, UK



Holger Stromberg
KUTCHIIN, Munich, GE



Paolo Griffa
AL CAFFÈ NAZIONALE,
Aorta, IT
🌟 MICHELIN



Iga Sarzyńska
IGA SARZYŃSKA,
Toruń, PL



Ørjan Johannessen
MIRABELLE,
Bekjarvik, Noruega

AMERICA



GRANT ACHATZ,
Alinea, Chicago
🌟🌟🌟 MICHELIN 2022



NARDA LEPES,
Argentina



German Martitegui,
TEGUI, Buenos Aires, AR



Lucas Fuente,
LA OBRERÍA, Uruguay



Hernan Montoya
CHEF MONT, Colombia



Anthony Vázquez
TANTA, Buenos Aires, AR



KEVIN GILLESPIE,
Atlanta



GASTON ACURIO, Perú



SERGIO PUGLIA,
Uruguay



Ennio Carota,
PASTAMORE, Chile



Gonzalo Aramburu,
ARAMBURU, Buenos Aires, AR



CULINARY
INSTITUTE OF AMERICA,
Napa



Pablo Massey, LA
PANADERÍA DE PABLO,
Buenos Aires, AR



Fernando Trocca
MOSTRADOR DE STA.
TERESITA, Uruguay



Pedro Fernández, The
Chef is Back, Colombia

Kitchen Sinks / Fregaderos de cocina

Neolith sees the kitchen as a place in which design and functionality, elegance and durability coexist.

Neolith concibe el mundo de la cocina como un entorno en el que conviven diseño y funcionalidad, elegancia y durabilidad.

The Neolith kitchen line provides a more holistic and minimalist look to the kitchen by incorporating Neolith Sinks, a kitchen sink line made of the same material as the kitchen countertop.

La línea de cocina Neolith, permite otorgar un aspecto más integral y minimalista a la cocina al incorporar la línea de fregaderos, Neolith Sinks, realizados en el mismo material que el utilizado en la encimera de cocina.

Using cutting-edge technologies, the material is curved to create gradual drainage slopes designed to facilitate fast water evacuation (pursuant to standard UNE-EN 14527) and to ensure resistance to temperature changes, making it durable and suitable for cleaning (pursuant to standard UNE-EN 13310).

Con técnicas de vanguardia se logra curvar el material hasta conseguir las pendientes de evacuación progresivas diseñadas para facilitar la rápida evacuación del agua (según la norma UNE-EN 14527) y también se consigue una resistencia a cambios de temperatura otorgando durabilidad y aptitud para la limpieza (según la norma UNE-EN 13310).

Neolith Sinks, a product with extraordinary features that introduces an integrated and functional kitchen concept.

Neolith Sinks, un elemento de características extraordinarias que presenta un concepto de cocina integrado y funcional.

AVAILABLE FORMATS / FORMATOS DISPONIBLES



AVAILABLE MODELS / MODELOS DISPONIBLES

THE NEW CLASSTONE

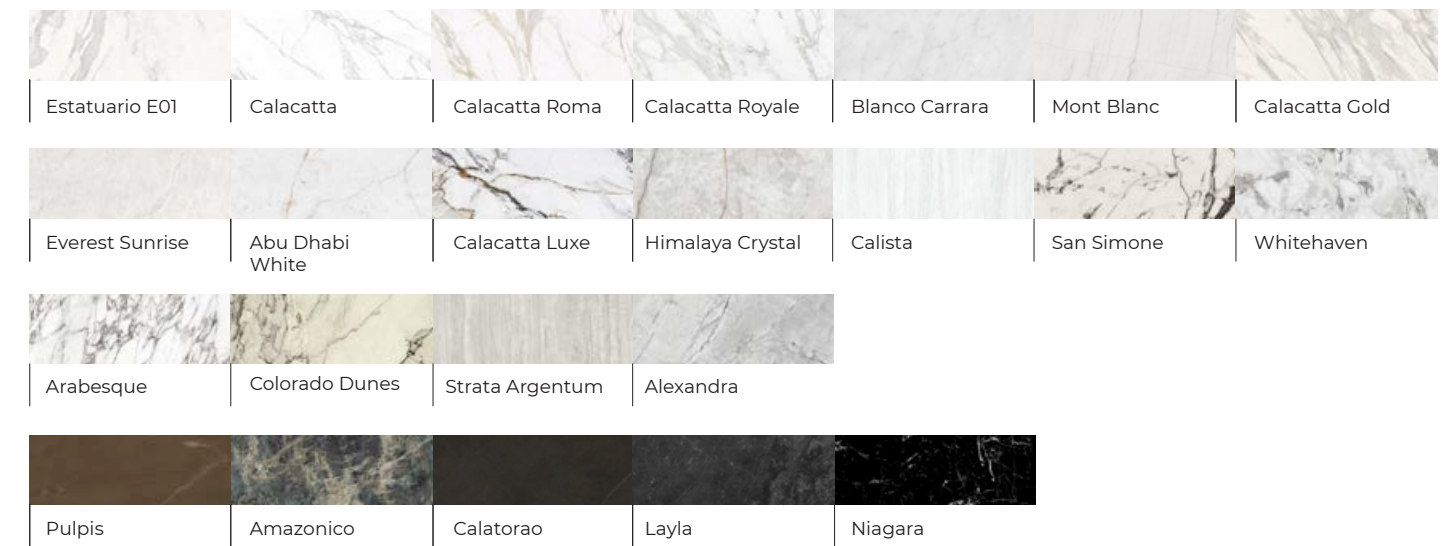

FUSION

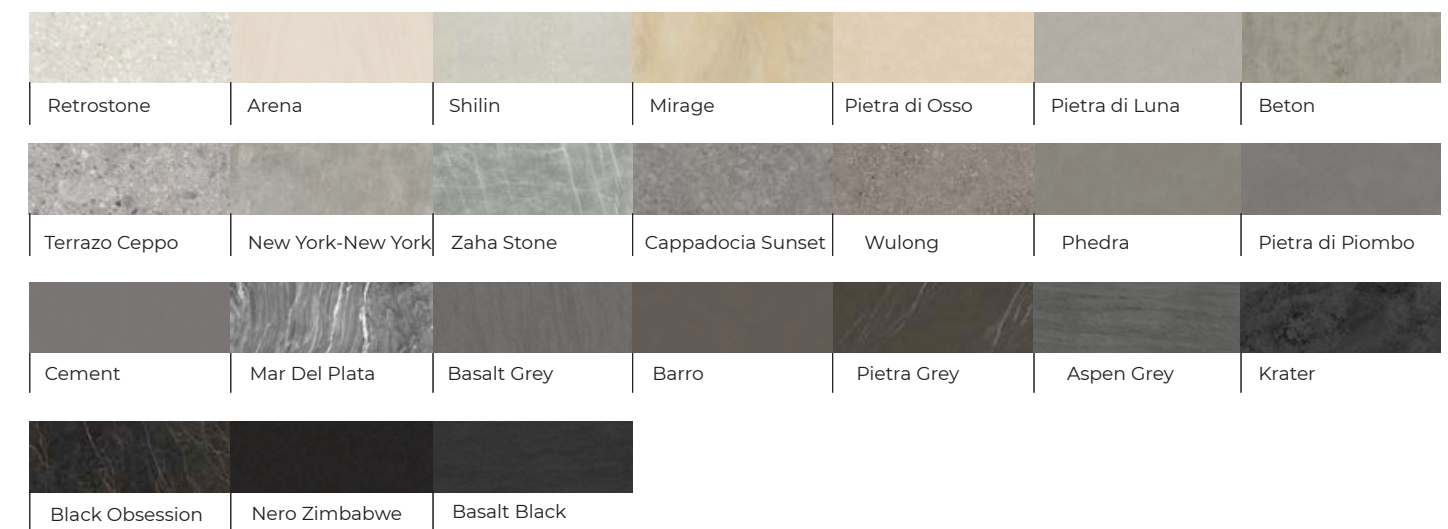

COLORFEEL

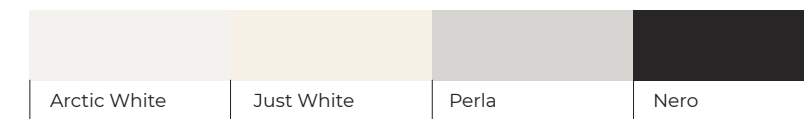

IRON

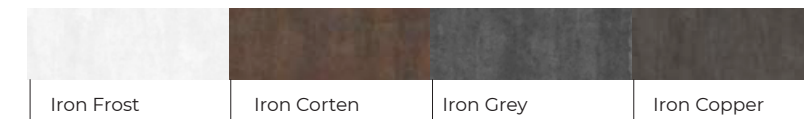

TIMBER

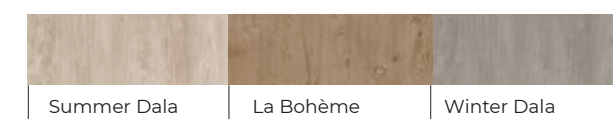

STEEL

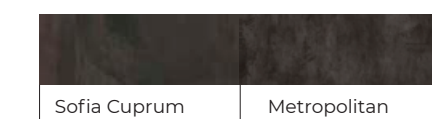

Please check models available for immediate delivery / Por favor consultar modelos para entrega inmediata.

“The design to enjoy every day”
“El diseño que se vive cada día”

NEOLITH BATHROOM Collection

Neolith surfaces and their textures, designs and colors create new trends in bathroom design, offering fresh, previously unimaginable possibilities.

Furthermore, thanks to the different formats and thicknesses available, the same material can be used throughout the whole bathroom - on floors, walls, sinks, shower trays and bathtubs - which translates into utmost cleanliness and esthetic uniformity. It is even possible to cover entire walls with a single piece, creating enveloping, harmonious spaces full of personality.

Las superficies Neolith, sus texturas, diseños y colores, crean nuevas tendencias en el diseño de los cuartos de baño, ofreciendo nuevas posibilidades, antes inimaginables.

Además, gracias a los diferentes formatos y grosores disponibles, se puede utilizar el mismo material en todo el baño: en suelos, paredes, lavabos, platos de ducha y bañeras. Lo que se traduce en máxima limpieza y uniformidad estética. Siendo posible, incluso, cubrir paredes enteras con una sola pieza, creando espacios envolventes, armoniosos y llenos de personalidad.



Calacatta Roma Silk
6 MM

THE
NEW CLASSTONE

Estuario E01 Silk
12 MM

THE
NEW CLASSTONE



WA RESIDENCE
Kota Baru Parahyangan, (Indonesia)

Interior Design: INERRE Interior
Architecture: Pranala Associates

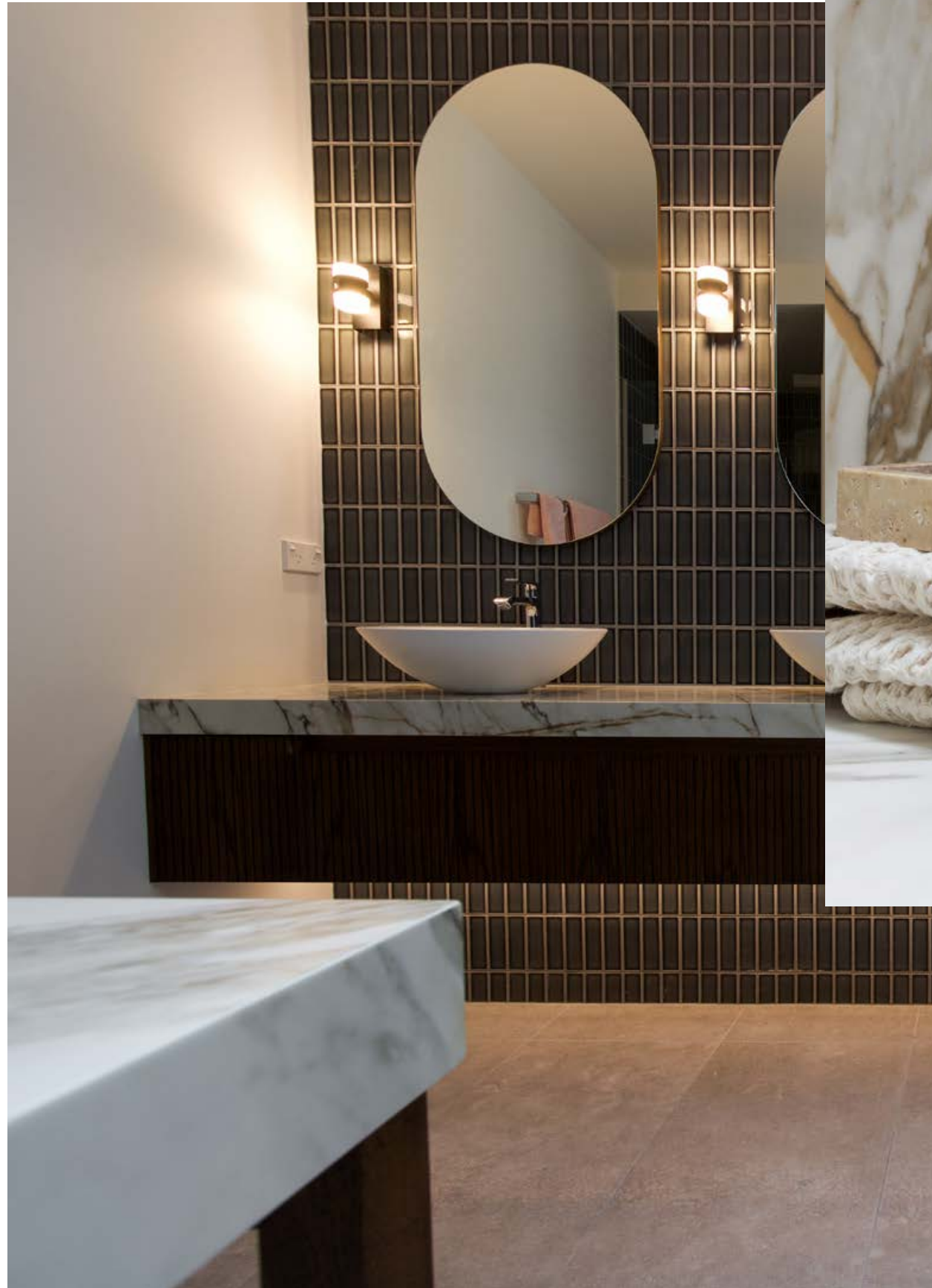

PRIVATE RESIDENCE,
Auckland, (New Zealand)

Design: Shane George
Image: Olivia Atkinson Design

Everest Sunrise Silk

THE
NEW CLASSTONE

Cappadocia Sunset Silk

FUSION

6 MM & 12 MM



BATHROOM



PRIVATE RESIDENCE,
Barcelona, (Spain)

Design: The Room Studio
Image: Mauricio Fuertes

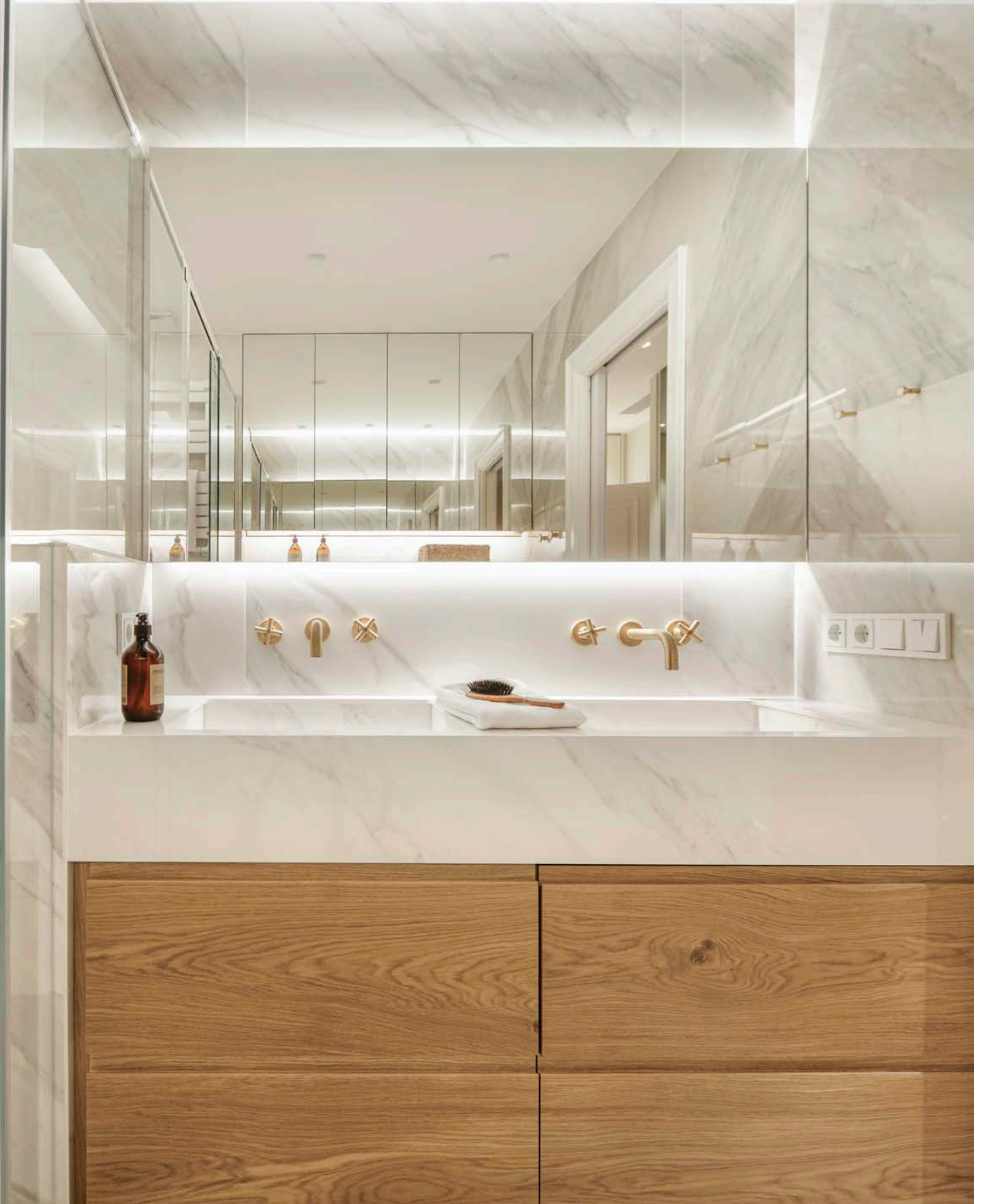



Whitehaven Ultrasoft
6 MM

THE
NEW CLASSTONE



BATHROOM

Cappadocia Sunset Silk

FUSION

6 MM & 12 MM



BATHROOM

Beton Silk | FUSION
12 MM

PRIVATE RESIDENCE
Melbourne, (Australia)

Design: Studio Griffiths
Image: Sharyn Cairns



BATHROOM

Shilin Slate | FUSION
6 MM & 12 MM



INTERHOTEL,
Madrid, (Spain)

Design: Sara Folch
Image: Paloma Pacheco



BATHROOM

Calista Silk
12 MM

THE
NEW CLASSTONE



BATHROOM



NEOLITH HEADQUARTERS,
Castellón, (Spain)

Design: Giuliana Barandarián

Metropolitan Steel Touch

STEEL

6 MM

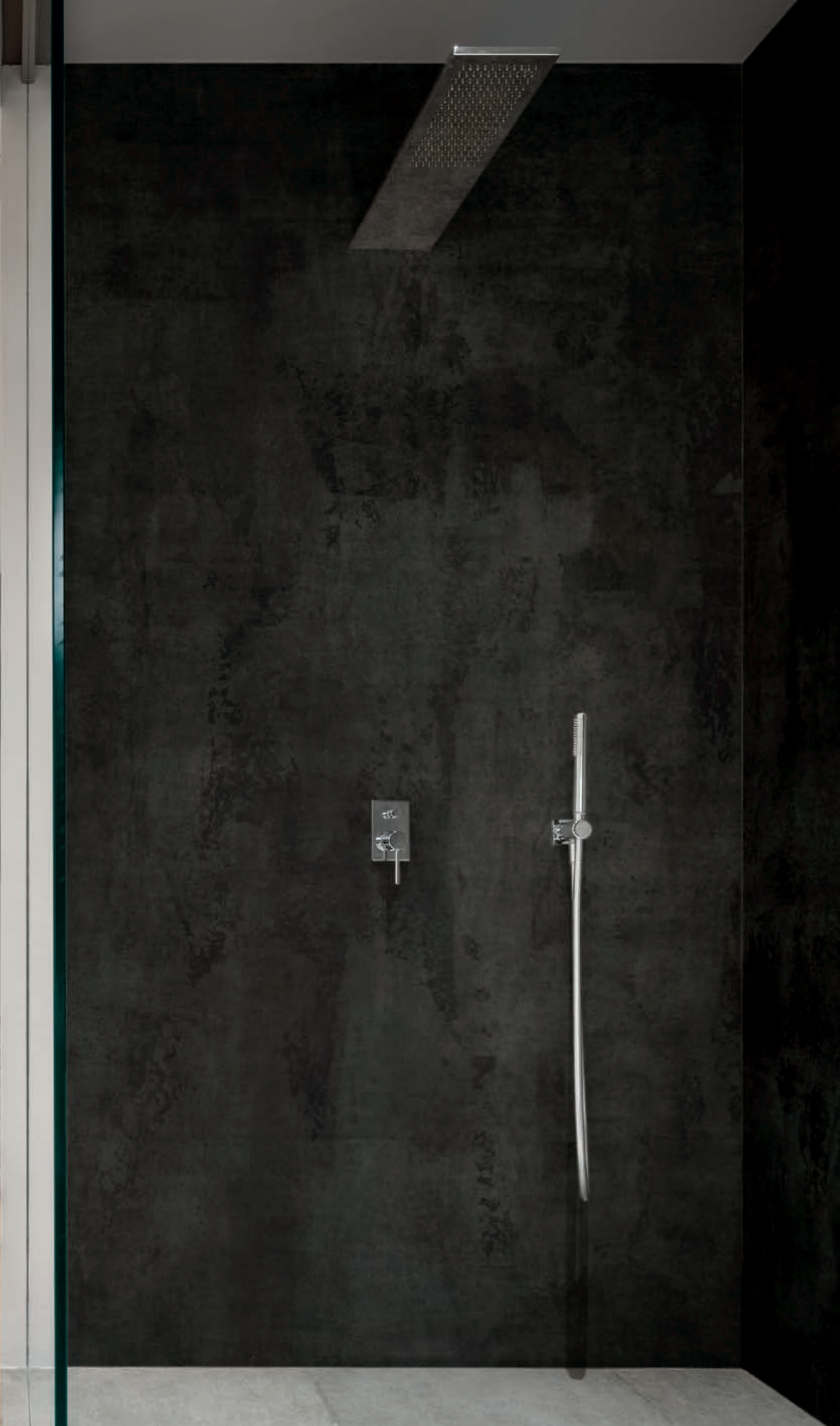

BATHROOM

Iron Frost Satin | IRON
6 MM



BATHROOM



PRIVATE RESIDENCE,
Barcelona, (Spain)

Design: The Room Studio
Image: Mauricio Fuertes

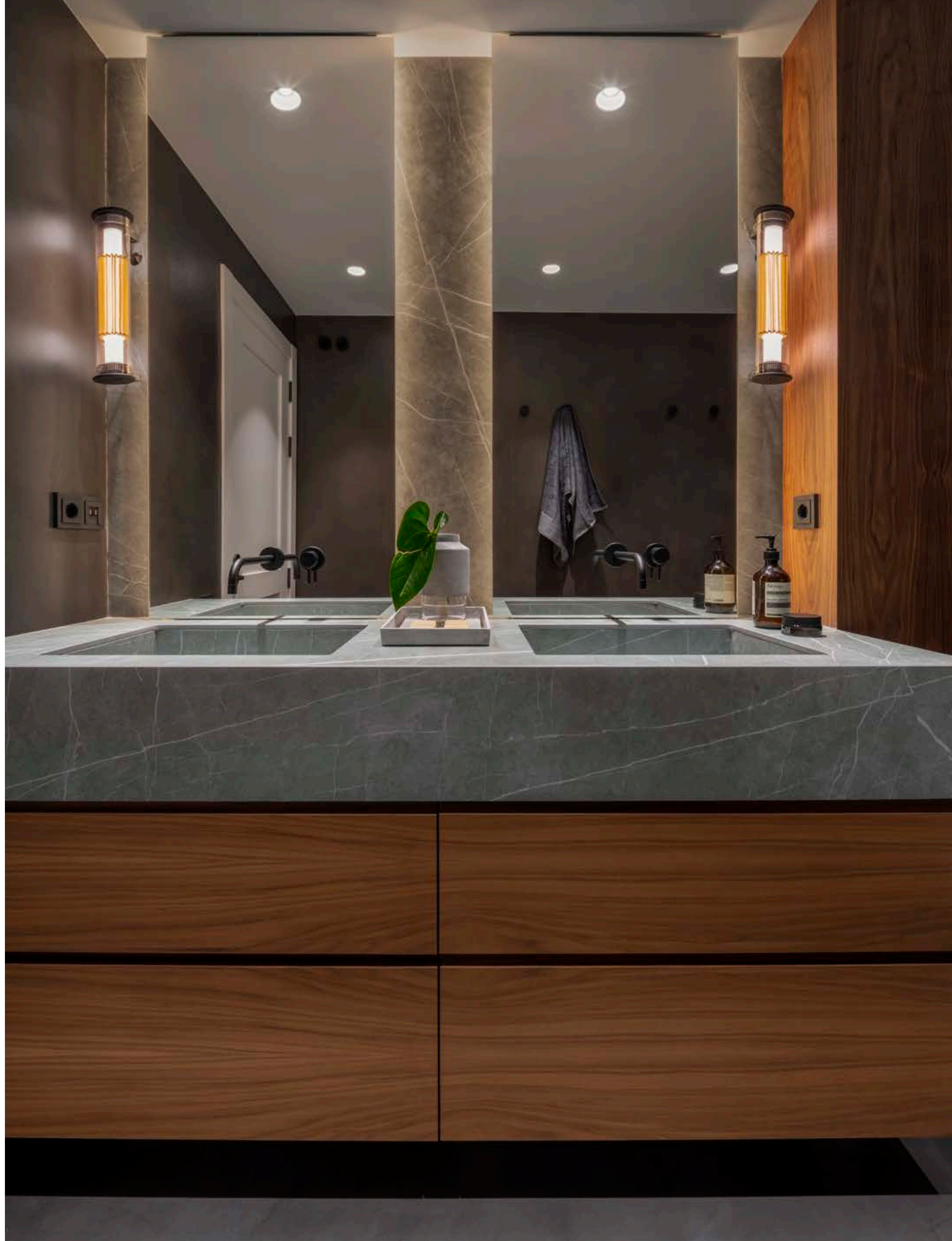

BATHROOM

Krater Riverwashed | FUSION

12 MM



Strata Argentum Riverwashed

12 MM

THE
NEW CLASSTONE



PRIVATE RESIDENCE,
Medellín, (Colombia)

Design: Arquitectura Mutuos
Fabricated: Artesa
Image: Carlos Velez



PRIVATE RESIDENCE,
(Colombia)

Design: Arquiara
Stonemason: Volterra Stone
Distributed: Vianova SAS
Image: Carlos Velez

Phedra Satin | FUSION

12 MM

PRIVATE RESIDENCE,
Oslo, (Norway)

Design: Huseby Kjokken
Distributed: Scan Granitt
Image: VP Living



BATHROOM

Iron Corten Satin | IRON
12 MM



BATHROOM

PRIVATE RESIDENCE
Wellington, (New Zealand)

Design: Happy Home Interiors

Blanco Carrara Silk
12 MM

THE
NEW CLASSTONE



PRIVATE RESIDENCE,
Oslo, (Norway)

Design: Huseby Kjekken
Distributed: Scan Granitt
Image: VP Living



BATHROOM

Neolith Piattibelli Shower Trays / Platos de ducha Neolith Piattibelli

The Neolith Piattibelli shower tray comes in a wide range of sizes and colors, making it the perfect solution for bathrooms. It is easy to install, one-piece and seamless.

El plato de ducha Neolith Piattibelli presenta una amplia gama de medidas y colores, convirtiéndose en la solución perfecta para el baño. Fácil de instalar, de una sola pieza, sin juntas.

The Piattibelli shower tray uses Neolith as the cladding material and features a completely slip-free finish, pursuant to AIDIMME/standard UNE EN 14527:2016+A1:2019 "Shower trays for domestic use". It is produced with Ultra Slim manufacturing technology, a patented system unique on the market, which molds the raw material to create a product that is only 23 mm thick.

It is ideal for remodeling as the thickness does not create barriers or differences in level at the shower entrance. Moreover, any possible filtration disappears since it's manufactured in a single, jointless piece. With this cutting-edge technology, the Neolith materials can be curved to create gradual drainage slopes designed to facilitate fast water evacuation (pursuant to AIDIMME certification/standard UNE EN 14527:2016+A1:2019). This technology integrates seamlessly with market-leading drain valves, creating the perfect combination of design and efficiency. Neolith does not manufacture the Piattibelli shower trays; it only distributes them in various markets.

Los platos de ducha Piattibelli, utilizan Neolith como superficie de revestimiento y presentan un acabado completamente antideslizante, según certificado AIDIMME /NORMA UNE EN 14527:2016+A1:2019 "Platos de ducha para uso doméstico". Está producido con la tecnología de fabricación Ultra Slim, un sistema patentado único en el mercado en el que se moldea la materia prima para conseguir un producto de solamente 23 mm de grueso.

Es ideal para la reforma, pues por su grueso no genera barreras ni escalones de acceso a la ducha. Además, al estar fabricado en una sola pieza, sin juntas, desaparece cualquier posibilidad de filtración.

Con esta tecnología de vanguardia se logra curvar Neolith hasta conseguir las pendientes de evacuación progresivas diseñadas para facilitar la rápida evacuación del agua (según certificado AIDIMME/NORMA UNE EN 14527:2016+A1:2019). Esta tecnología se integra a la perfección con válvulas de desagüe líderes en el mercado creando la combinación perfecta entre diseño y eficacia. Neolith no fabrica los platos de ducha Piattibelli pero actúa como comercializadora en distintos mercados.

AVAILABLE FORMATS / FORMATOS DISPONIBLES

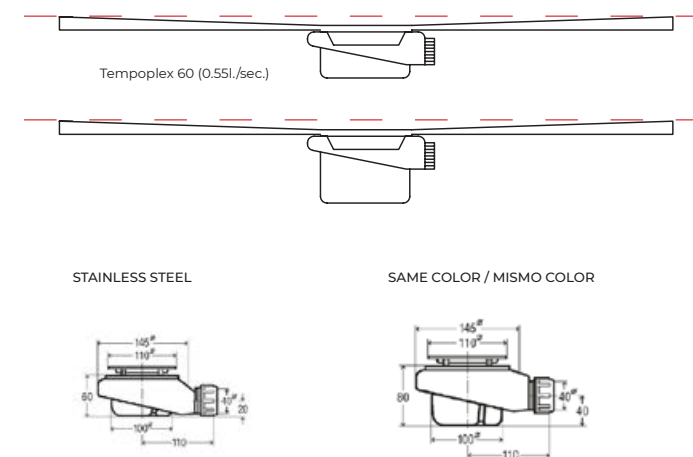
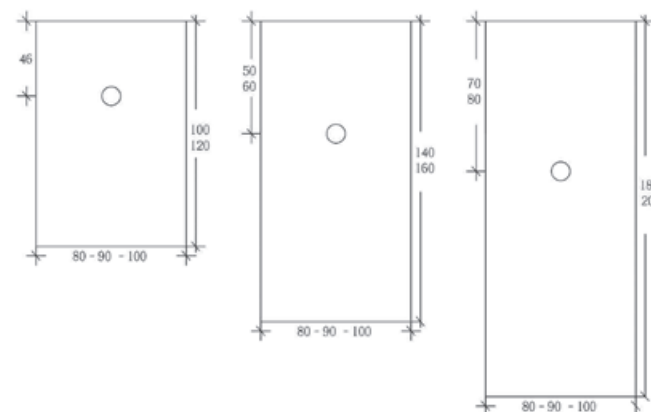

AVAILABLE MODELS / MODELOS DISPONIBLES

THE NEW CLASSTONE

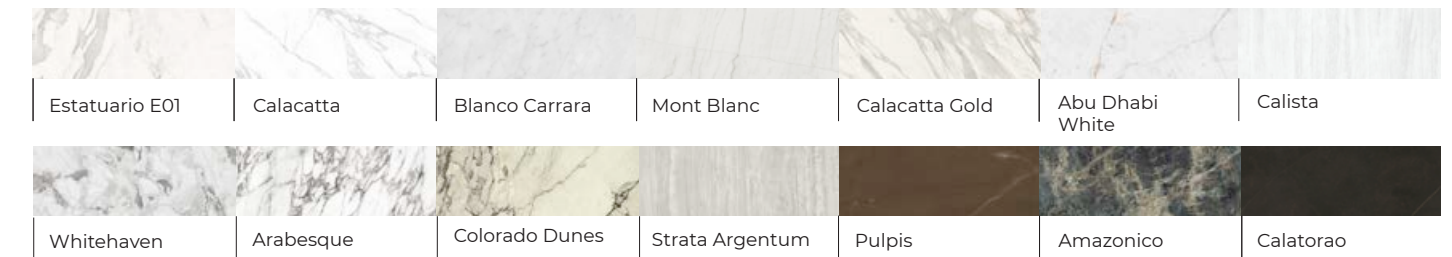

FUSION



COLORFEEL

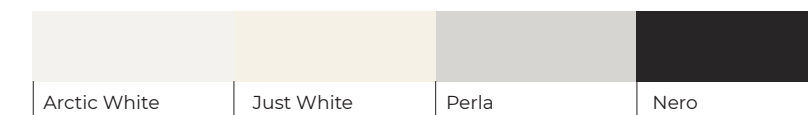

IRON



BARRO SATIN



CALACATA SILK

Please check models available for immediate delivery / Por favor consultar modelos para entrega inmediata.

Bathroom Sinks / Lavabos de baño

Neolith surfaces are the best choice for bathrooms: the temple of cleanliness.

Las superficies Neolith son la mejor elección para el cuarto de baño: el templo de la limpieza.

The Neolith bathroom line gives a more holistic and minimalist look to spaces by incorporating the Neolith sink line made of the same material as that used in the countertops. Using cutting-edge technologies, the material is curved to achieve gradual drainage slopes designed to facilitate fast water evacuation (pursuant to standard UNE-EN 14527) and to ensure resistance to temperature changes, making it durable and suitable for cleaning (pursuant to standard UNE-EN 13310). Neolith Sinks, a product with extraordinary features that introduces an integrated and functional bathroom concept.

La línea de baño Neolith, permiten otorgar un aspecto más integral y minimalista a los espacios al incorporar la línea de lavabos Neolith realizados en el mismo material que el utilizado en las encimeras. Con técnicas de vanguardia se logra curvar el material hasta conseguir las pendientes de evacuación progresivas diseñadas para facilitar la rápida evacuación del agua (según la norma UNE-EN 14527) y también se consigue una resistencia a cambios de temperatura otorgando durabilidad y aptitud para la limpieza (según la norma UNE-EN 13310). Neolith lavabos, un elemento de características extraordinarias que presenta un concepto de baño integrado y funcional.



500 x 300 mm / 20" x 11 4/5"



BIG SIZE: 700 x 300 mm / 27 1/2" x 11 1/2"

AVAILABLE MODELS / MODELOS DISPONIBLES

THE NEW CLASSTONE

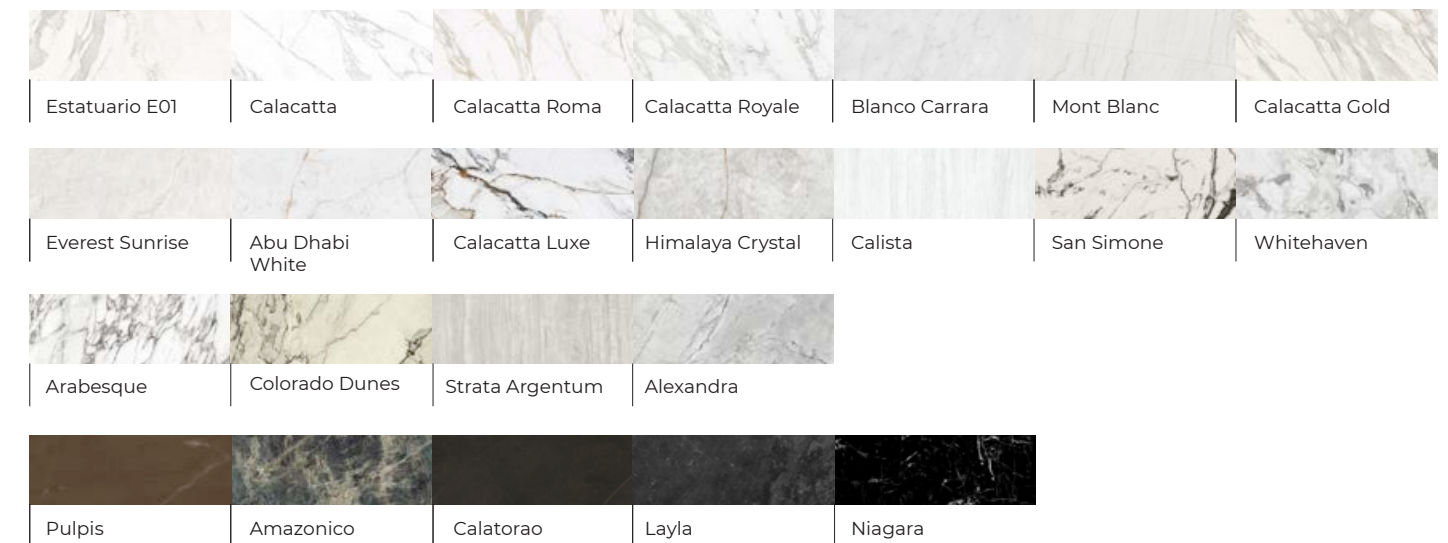

FUSION

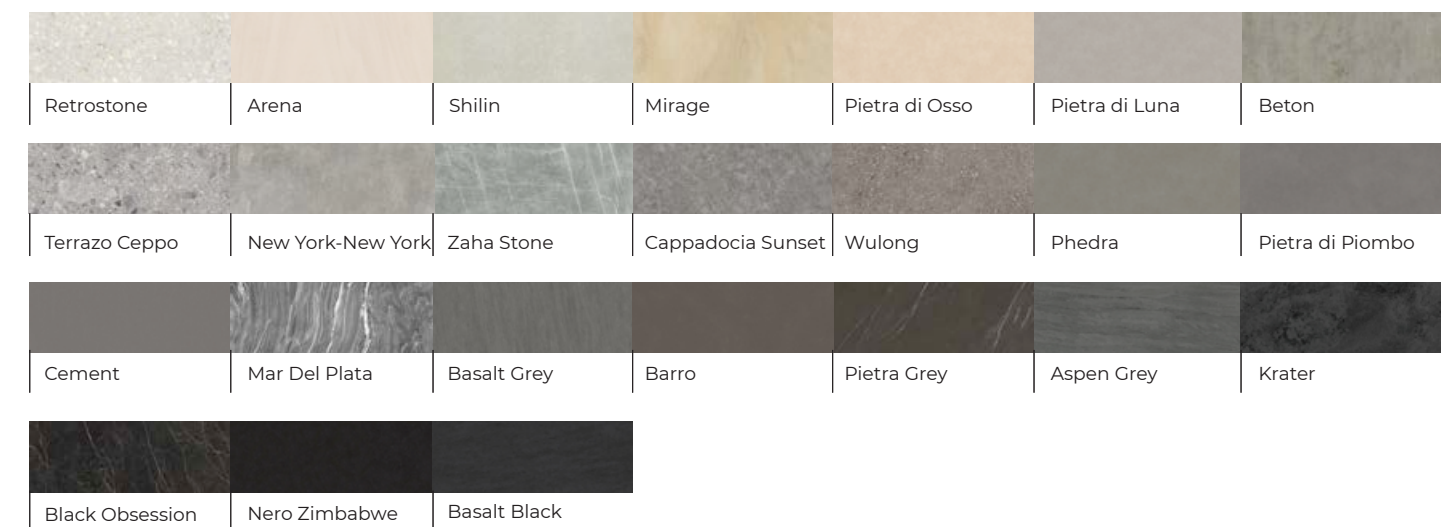

COLORFEEL



IRON



TIMBER

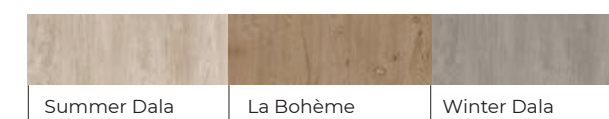

STEEL

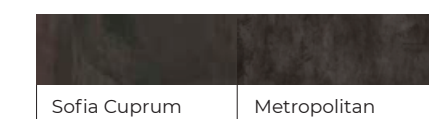

Please check models available for immediate delivery / Por favor consultar modelos para entrega inmediata.

NEOLITH GALLERY

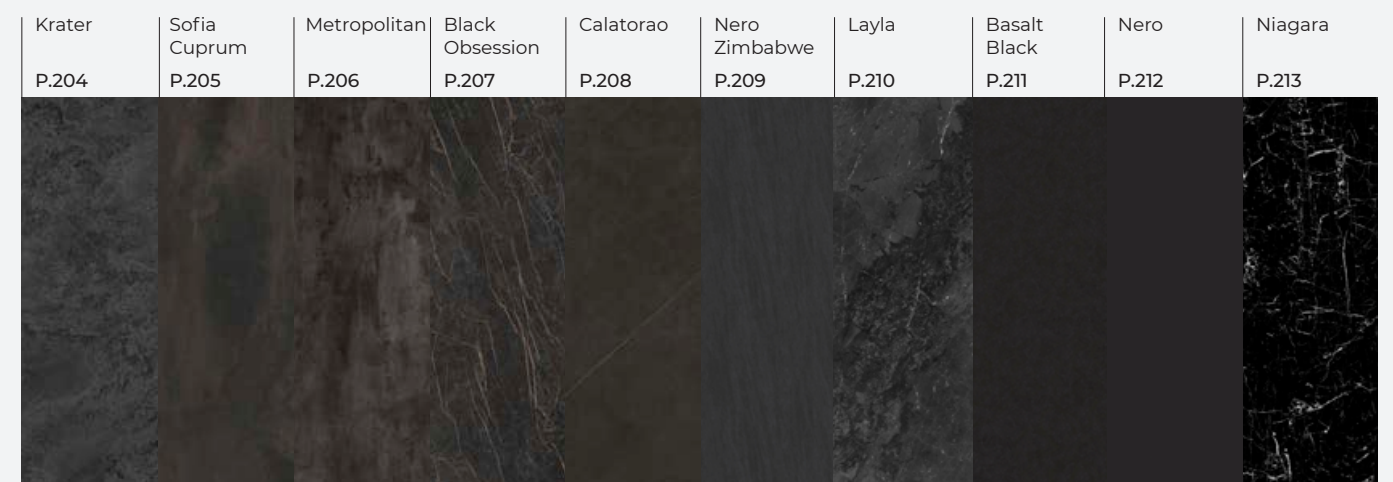
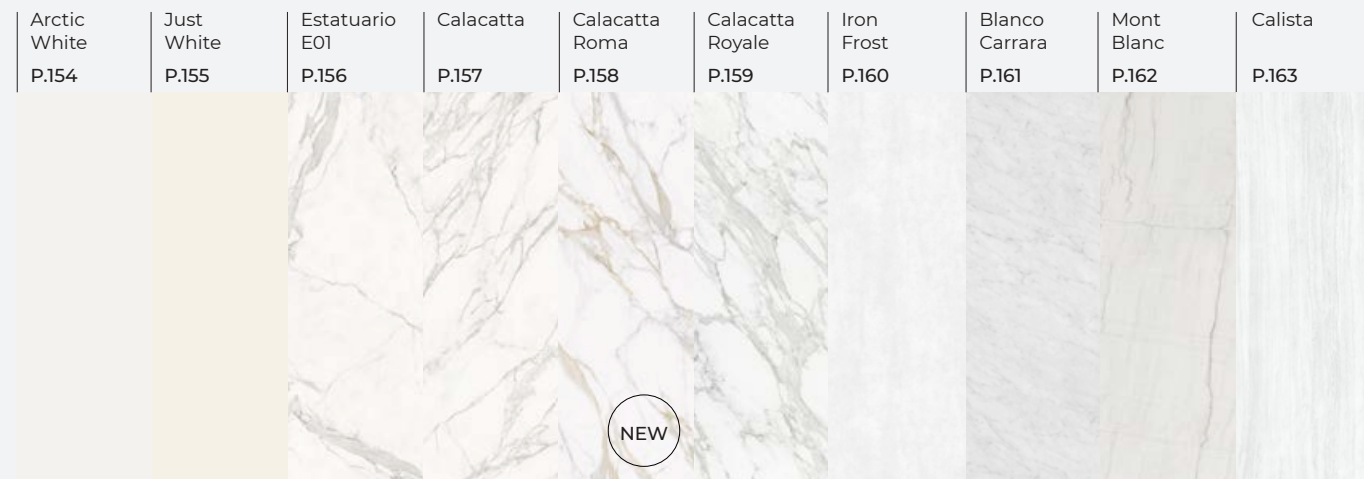

Arctic White

COLORFEEL

Satin
Silk
Nanotech Polished

3 MM
6 MM
12 MM
20 MM

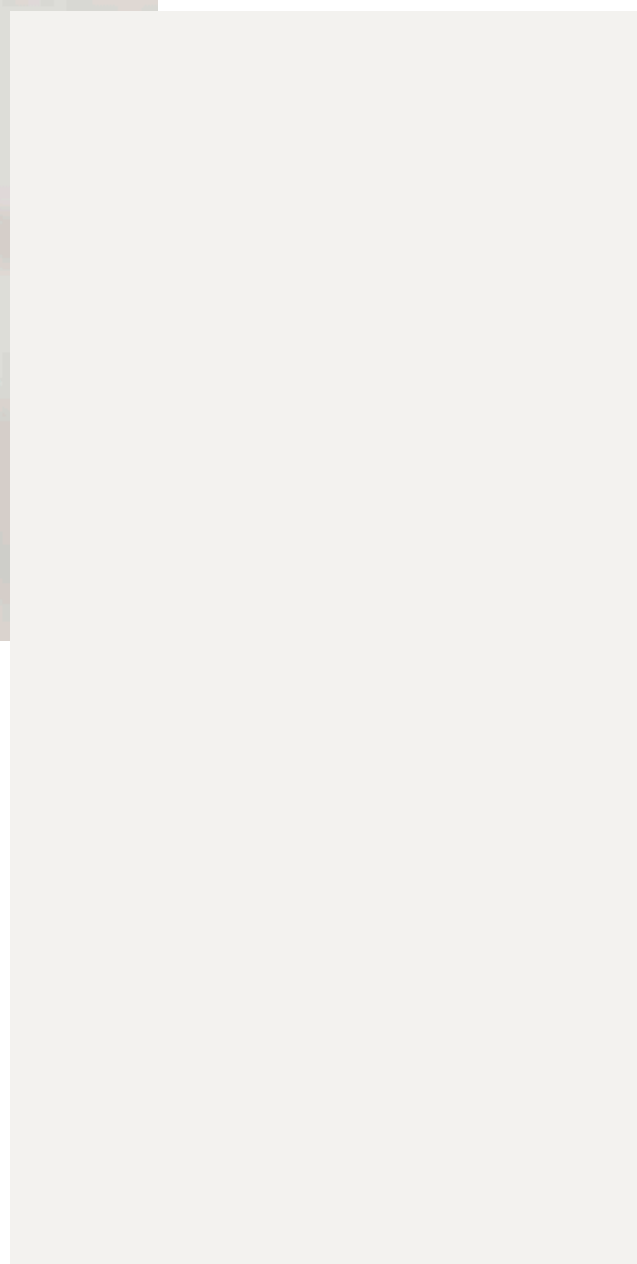

Full slab image / Imagen tabla completa

Just White

COLORFEEL

Silk

3 MM
6 MM
12 MM
20 MM

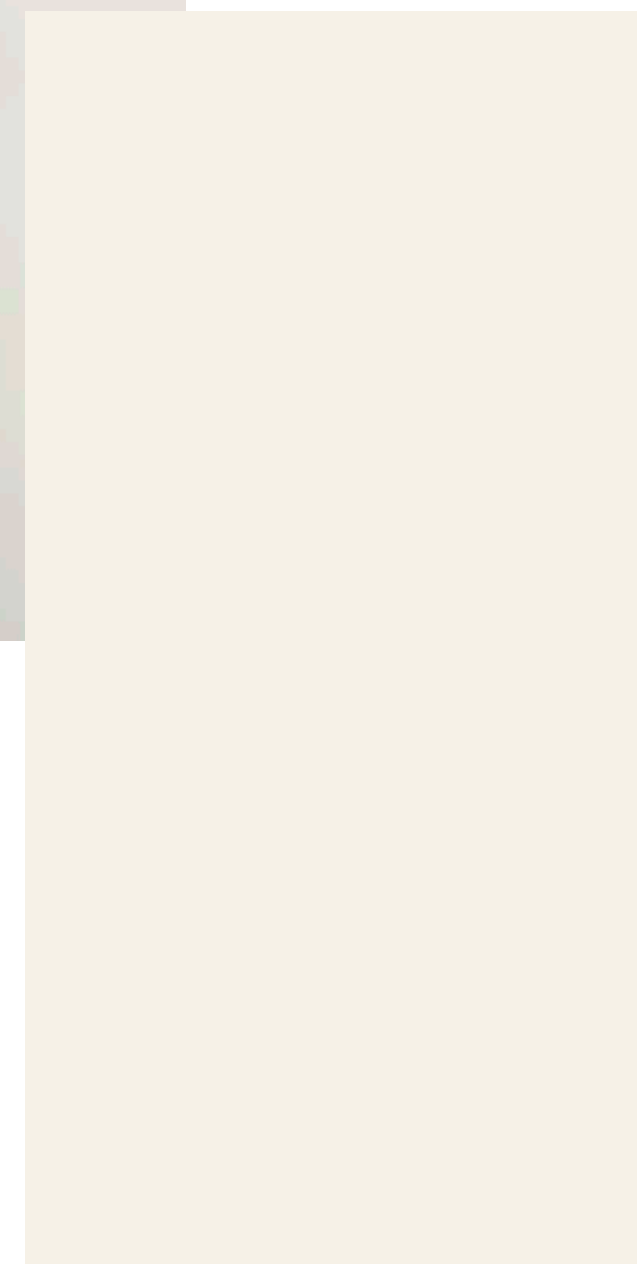
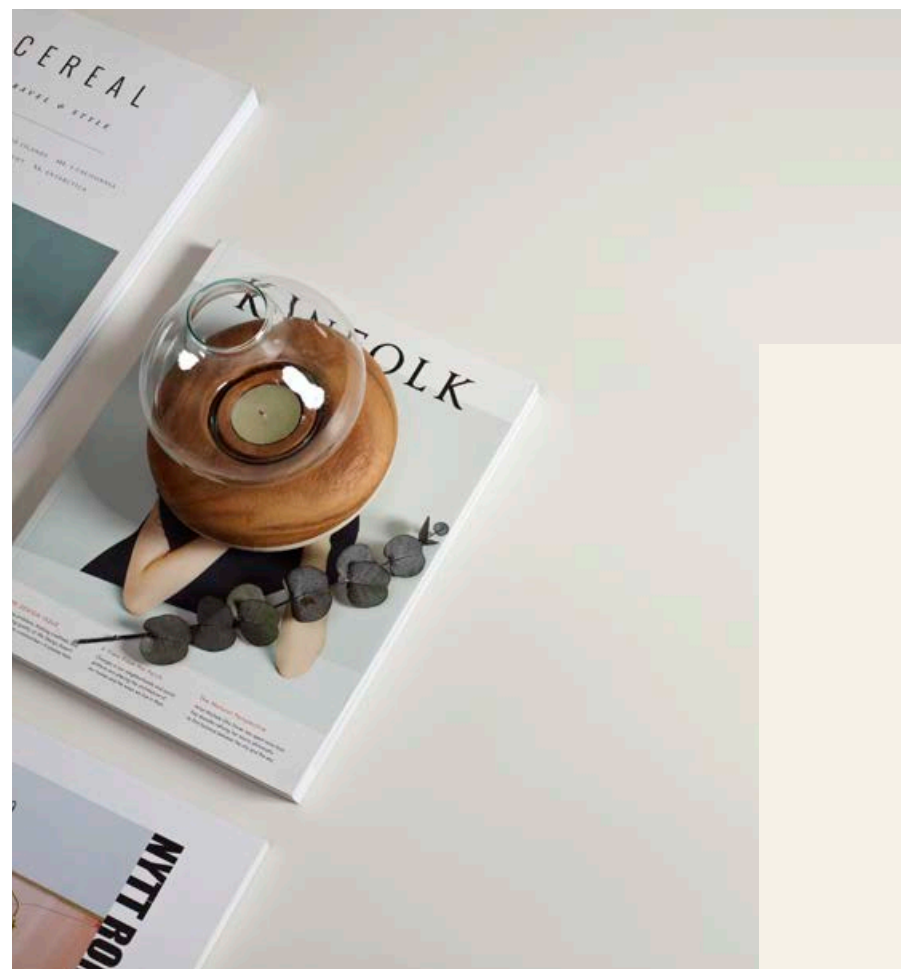

Full slab image / Imagen tabla completa

Estatuario

THE
NEW CLASSTONE

Silk
Décor Polished
Ultrasoft

3 MM
6 MM
12 MM
20 MM



Full slab image / Imagen tabla completa

Calacatta

THE
NEW CLASSTONE

Silk
Décor Polished
Ultrasoft

3 MM
6 MM
12 MM
20 MM

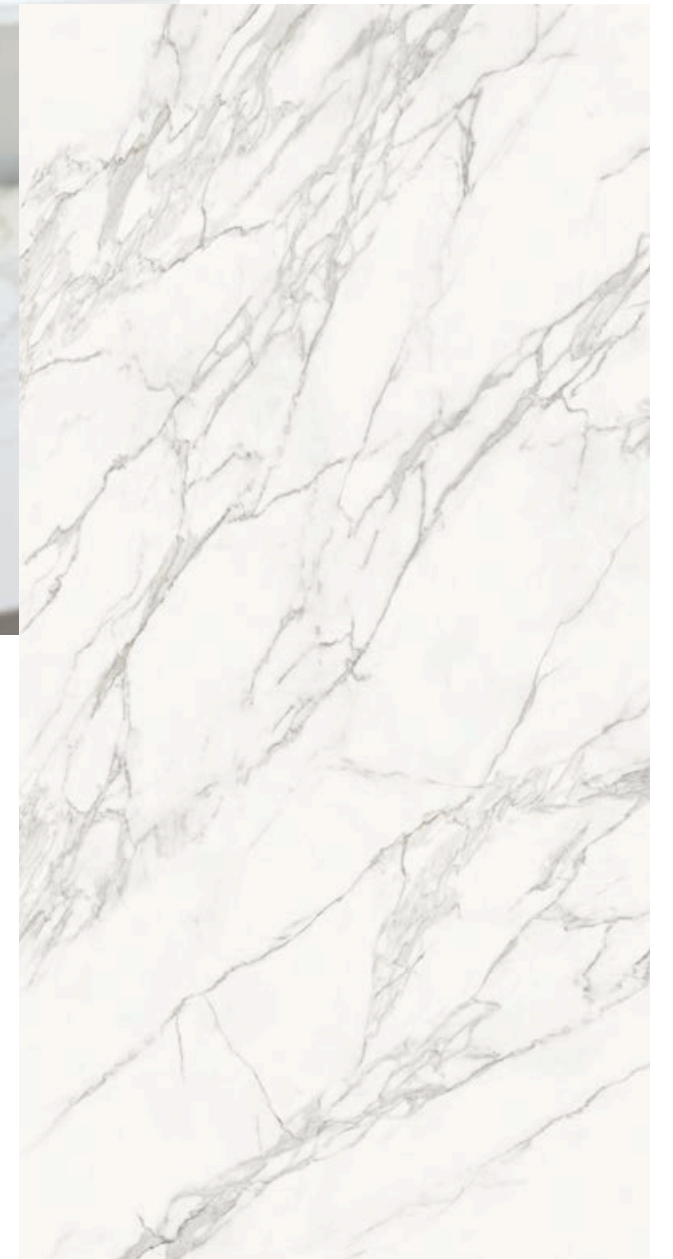

Full slab image / Imagen tabla completa

Calacatta Roma

THE
NEW CLASSTONE

Silk

6 MM
12 MM
20 MM

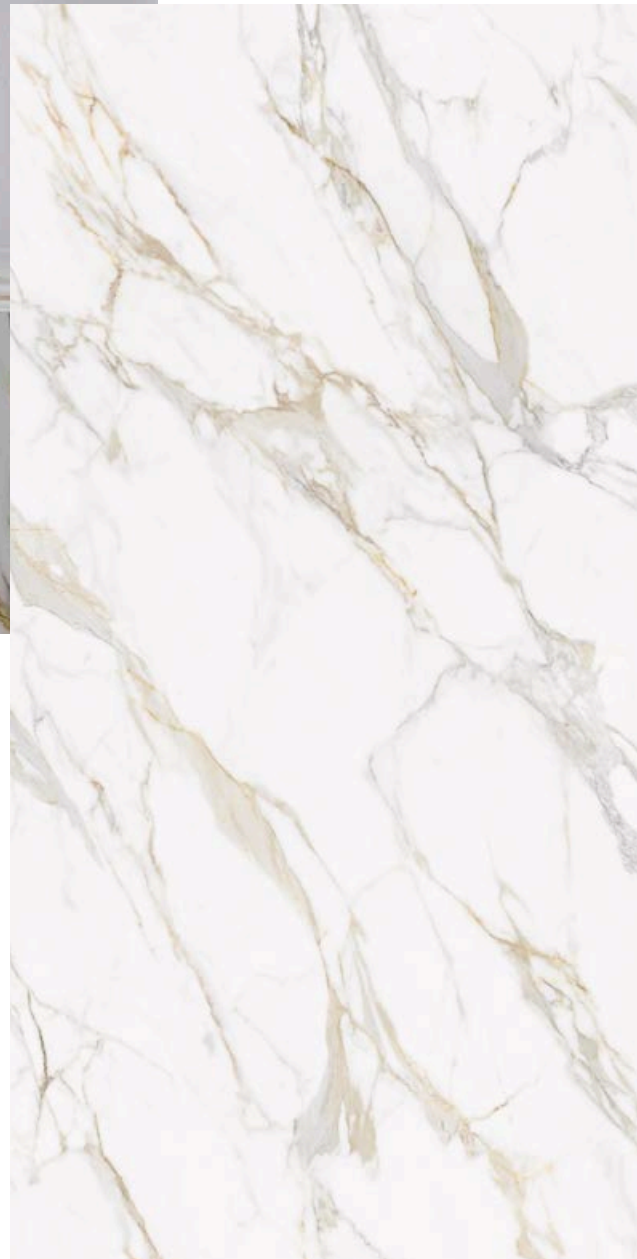

Full slab image / Imagen tabla completa

Calacatta Royale

THE
NEW CLASSTONE

Silk
Décor Polished
Ultrasoft

6 MM
12 MM
20 MM



Full slab image / Imagen tabla completa

NEW

Check with your local distributor for availability of the new Neolith models.
Consulta con tu distribuidor local la disponibilidad de los nuevos modelos Neolith

Iron Frost

IRON

Satin

3 MM
6 MM
12 MM



Full slab image / Imagen tabla completa

Blanco Carrara

THE
NEW CLASSTONE

Silk

3 MM
6 MM
12 MM

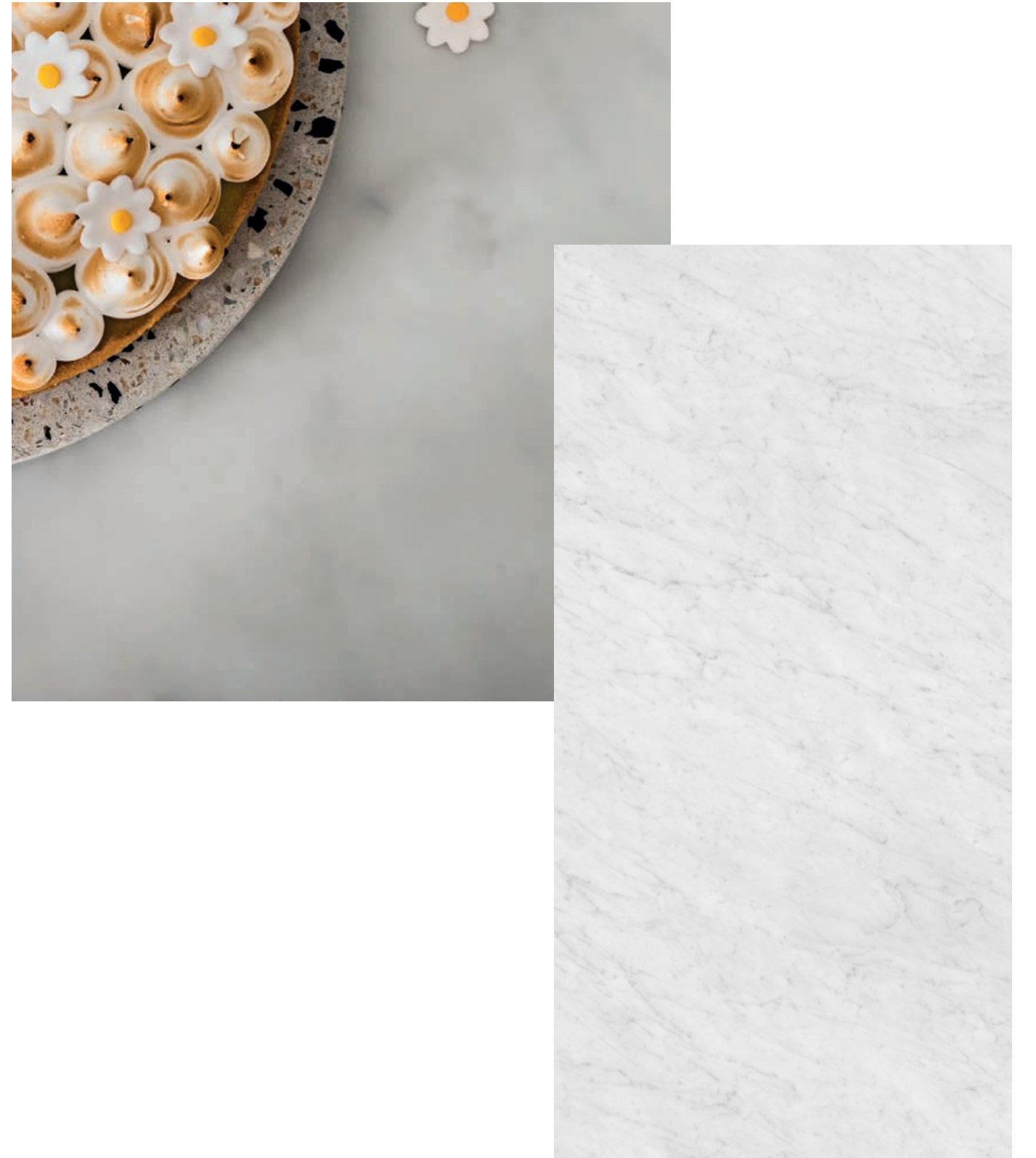

Full slab image / Imagen tabla completa

Mont Blanc

THE
NEW CLASSTONE

Silk

3 MM
6 MM
12 MM
20 MM



Full slab image / Imagen tabla completa

Calista

THE
NEW CLASSTONE

Silk
Décor Polished
Ultrasoft

3 MM
6 MM
12 MM
20 MM



Full slab image / Imagen tabla completa

Calacatta Gold

THE
NEW CLASSTONE

Silk
Décor Polished
Ultrasoft

3 MM
6 MM
12 MM
20 MM

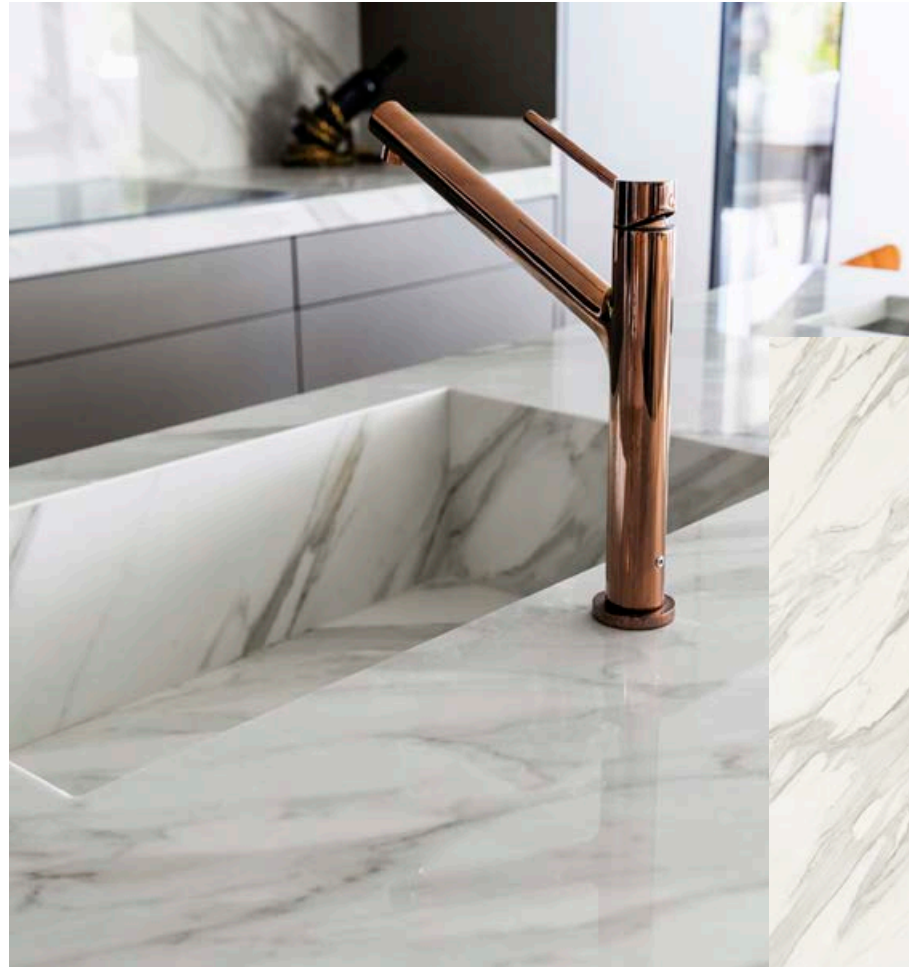

Full slab image / Imagen tabla completa

Everest Sunrise

THE
NEW CLASSTONE

Silk
Décor Polished
Ultrasoft

6 MM
12 MM
20 MM

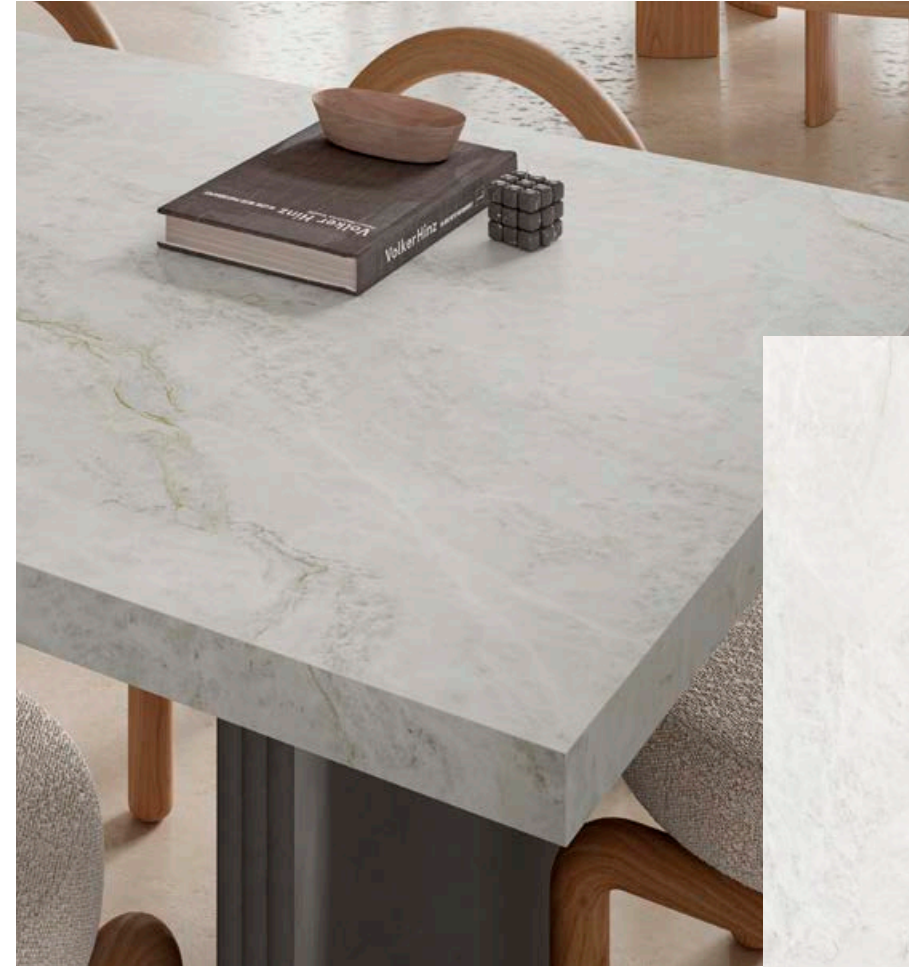

Full slab image / Imagen tabla completa

NEW

Check with your local distributor for availability of the new Neolith models.
Consulta con tu distribuidor local la disponibilidad de los nuevos modelos Neolith

Abu Dhabi White

THE
NEW CLASSTONE

Silk
Décor Polished

3 MM
6 MM
12 MM
20 MM



Full slab image / Imagen tabla completa

Calacatta Luxe

THE
NEW CLASSTONE

Silk
Ultrasoft

6 MM
12 MM

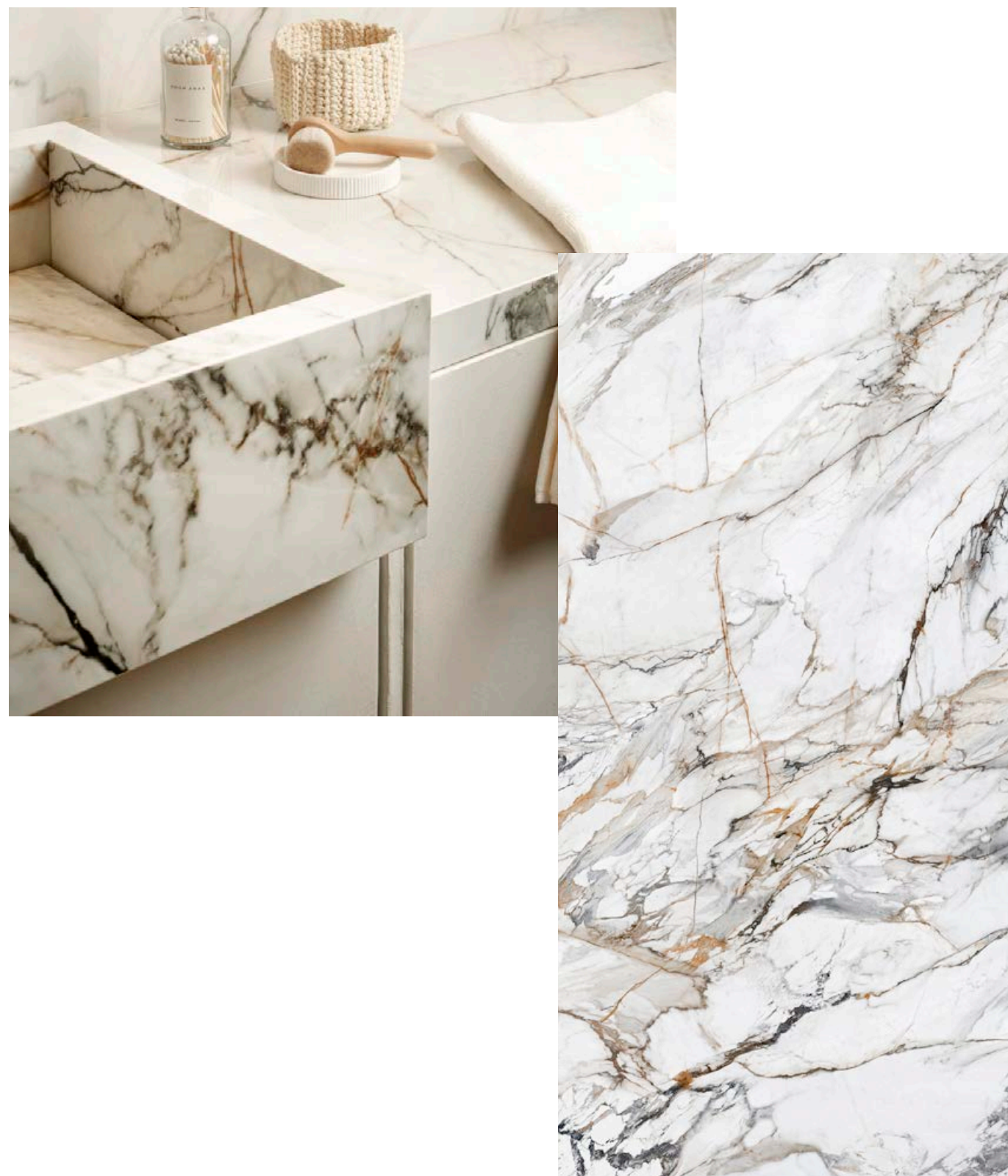

Full slab image / Imagen tabla completa

Himalaya Crystal

THE
NEW CLASSTONE

Silk
Décor Polished
Ultrasoft

6 MM
12 MM
20 MM



Full slab image / Imagen tabla completa

Alexandra

THE
NEW CLASSTONE

Silk
Décor Polished
Ultrasoft

6 MM
12 MM
20 MM



Full slab image / Imagen tabla completa

Retrostone

FUSION

Silk

6 MM
12 MM
20 MM



Full slab image / Imagen tabla completa

San Simone

THE
NEW CLASSTONE

Silk
Décor Polished
Ultrasoft

6 MM
12 MM
20 MM

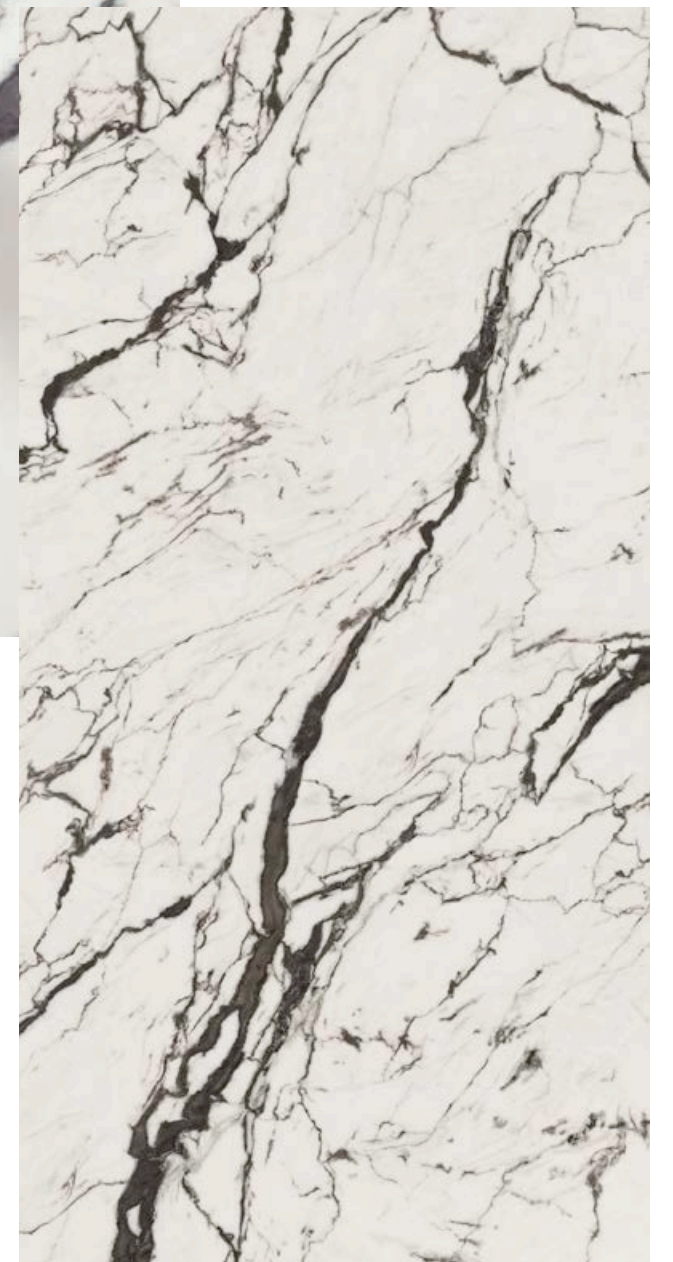

Full slab image / Imagen tabla completa

Arabesque

THE
NEW CLASSTONE

Silk
Décor Polished
Ultrasoft

3 MM
6 M
12 MM
20 MM



Full slab image / Imagen tabla completa

Whitehaven

THE
NEW CLASSTONE

Silk
Décor Polished
Ultrasoft

3 MM
6 MM
12 MM
20 MM

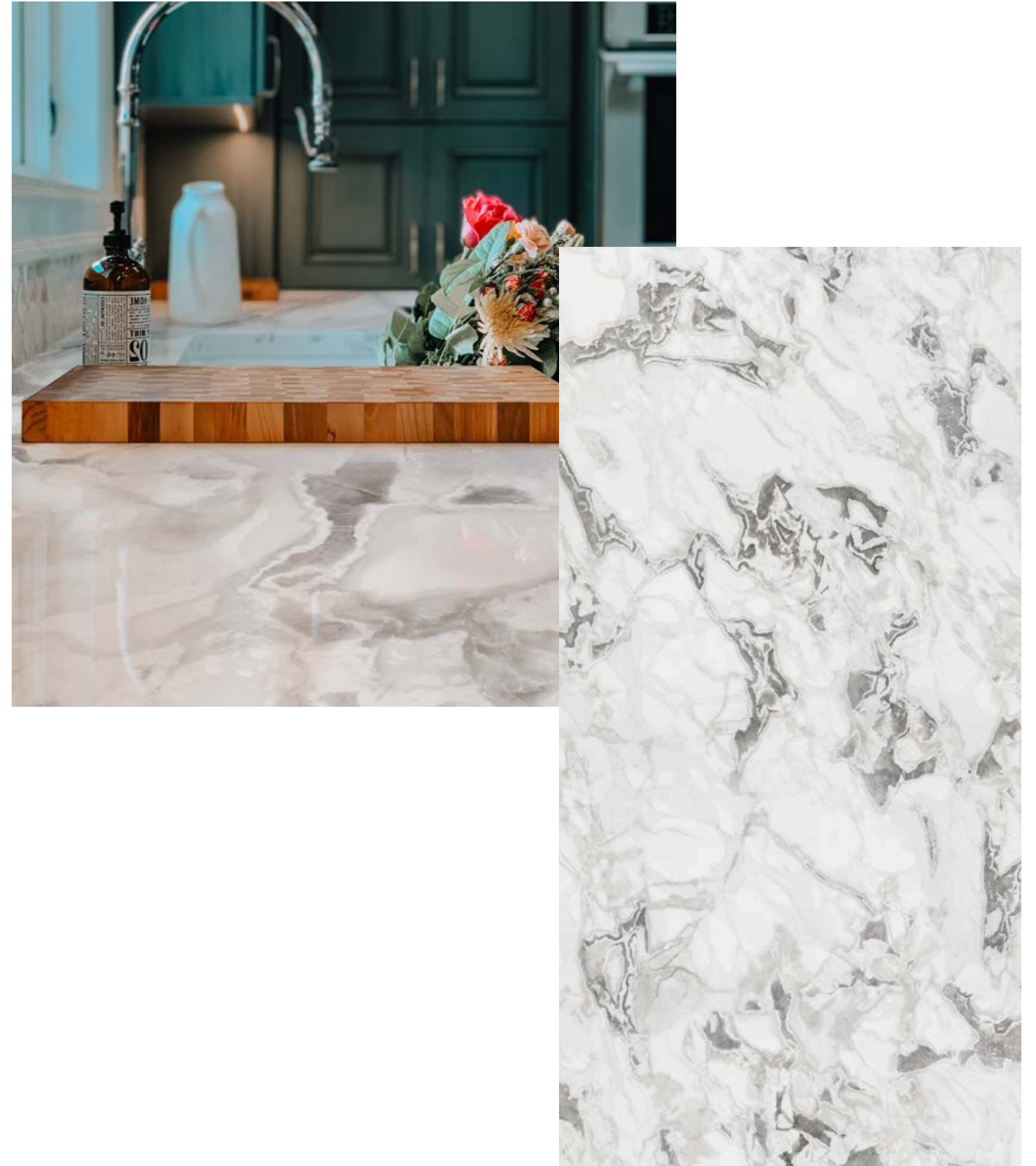

Full slab image / Imagen tabla completa

Colorado Dunes

THE
NEW CLASSTONE

Silk
Décor Polished
Ultrasoft

3 MM
6 MM
12 MM
20 MM



Full slab image / Imagen tabla completa

Arena

FUSION

Satin

3 MM
6 MM
12 MM



Full slab image / Imagen tabla completa

Perla

COLORFEEL

Satin

3 MM
6 MM

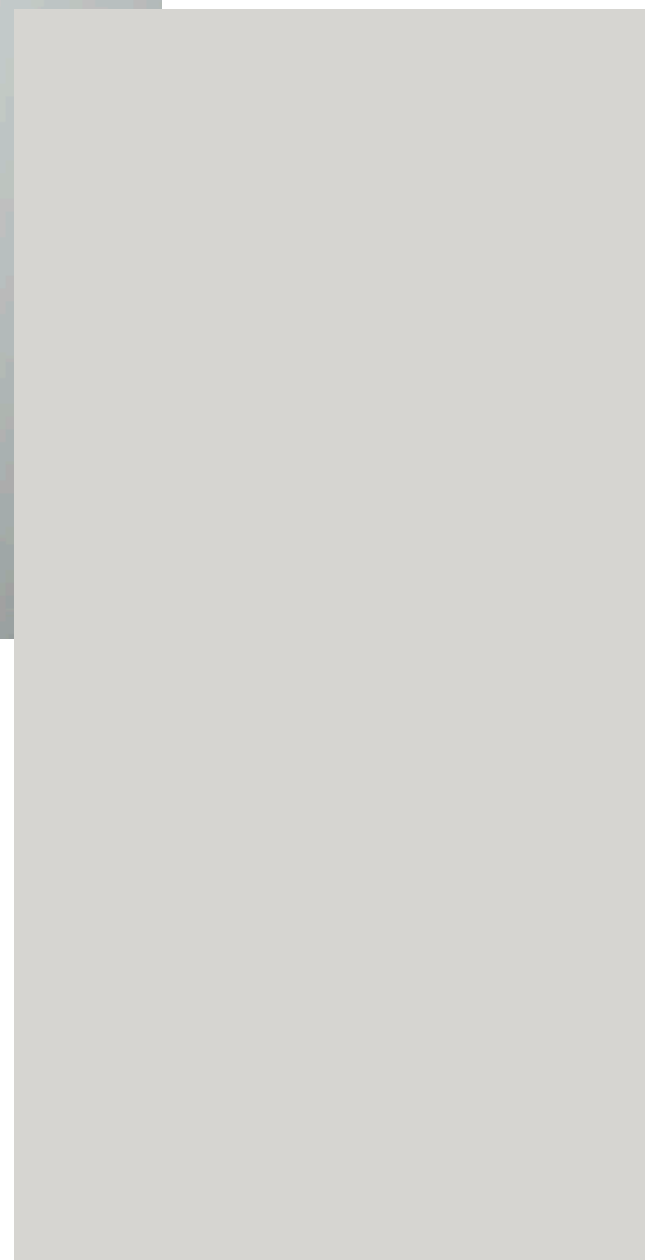

Full slab image / Imagen tabla completa

Strata Argentum

FUSION

Riverwashed

3 MM
6 MM
12 MM



Full slab image / Imagen tabla completa

Winter Dala

TIMBER

Silk

6 MM
12 MM



Full slab image / Imagen tabla completa

Mirage

FUSION

Silk

6 MM
12 MM

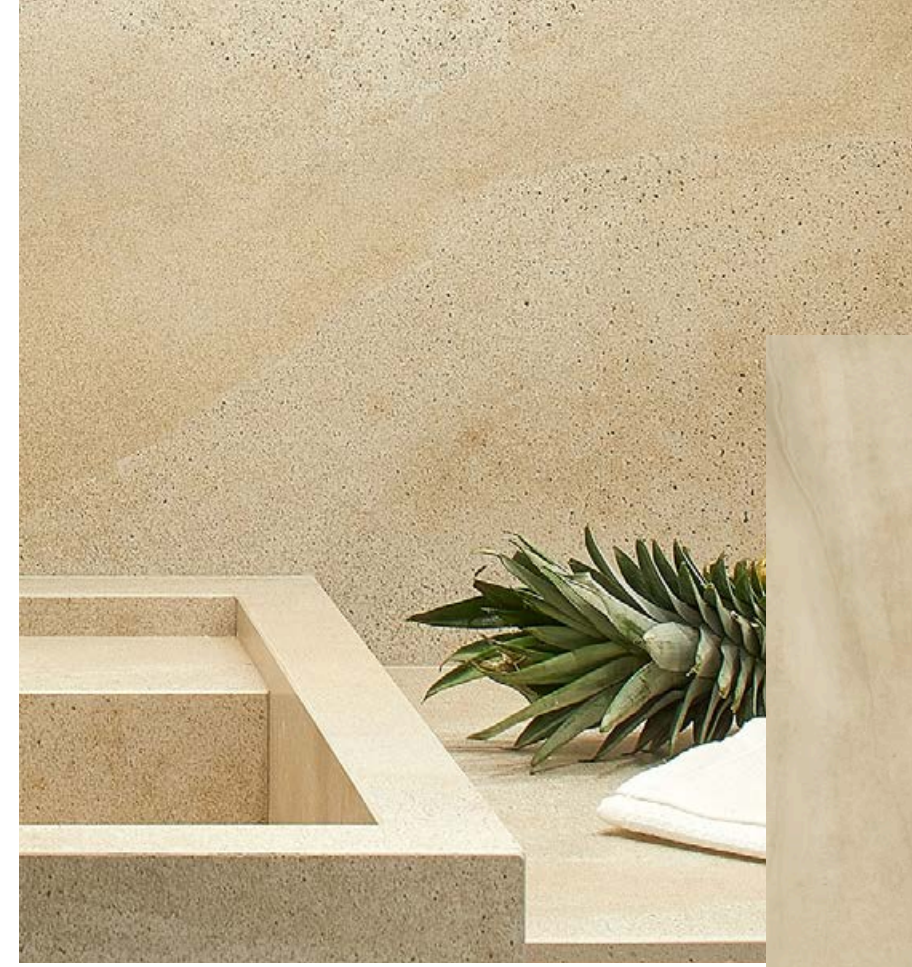

Full slab image / Imagen tabla completa

Summer Dala

TIMBER

Silk

6 MM
12 MM



Full slab image / Imagen tabla completa

La Bohemè

TIMBER

Satin

6 MM
12 MM



Full slab image / Imagen tabla completa

Pietra di Osso

FUSION

Silk

3 MM
6 MM
12 MM
20 MM

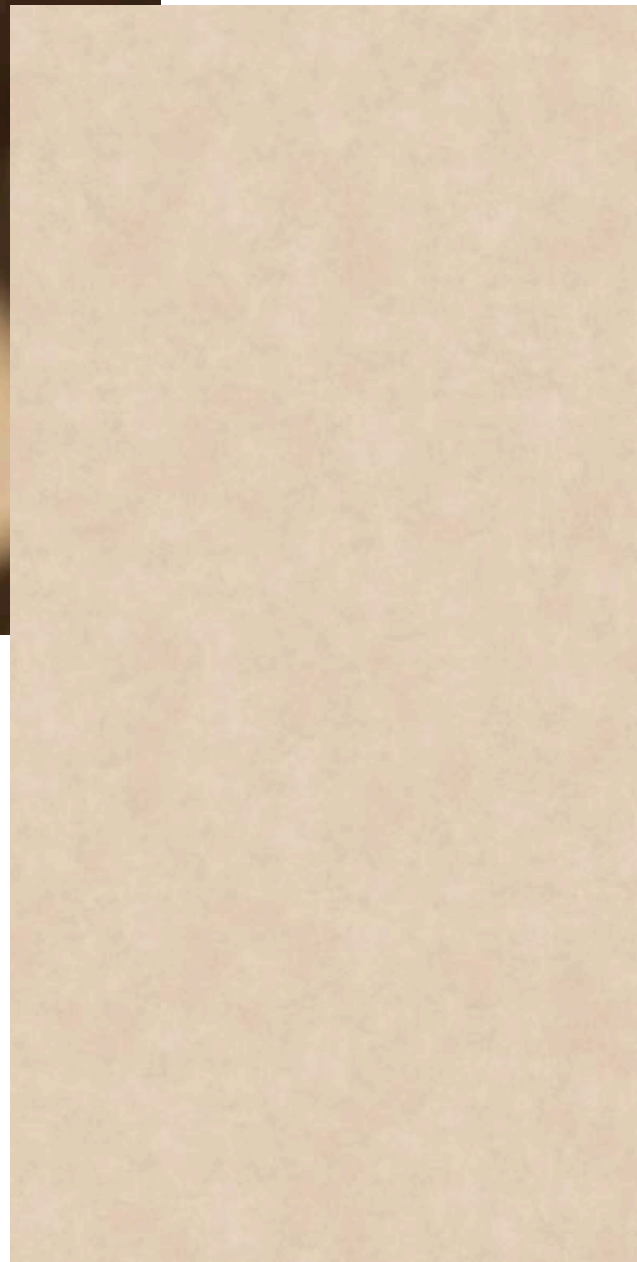

Full slab image / Imagen tabla completa

Shilin

FUSION

Silk
Riverwashed
Slate

3 MM
6 MM
12 MM
20 MM



Full slab image / Imagen tabla completa

Pietra di Luna

FUSION

Silk

3 MM
6 MM
12 MM
20 MM

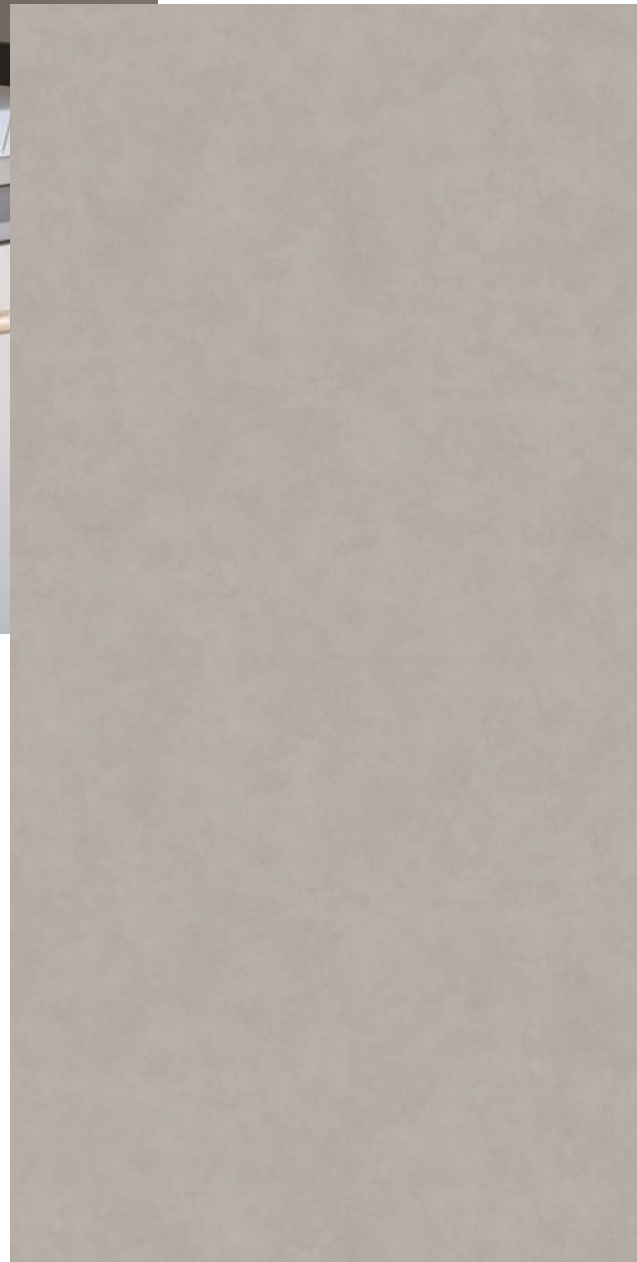

Full slab image / Imagen tabla completa

Beton

FUSION

Silk
Riverwashed

6 MM
12 MM
20 MM



Full slab image / Imagen tabla completa

Terrazzo Ceppo

FUSION

Silk

6 MM
12 MM



Full slab image / Imagen tabla completa

New York-New York

FUSION

Silk

3 MM
6 MM
12 MM
20 MM



Full slab image / Imagen tabla completa

Zaha Stone

FUSION

Silk

3 MM
6 MM
12 MM
20 MM



Full slab image / Imagen tabla completa

Cappadocia Sunset

FUSION

Silk

3 MM
6 MM
12 MM
20 MM



Full slab image / Imagen tabla completa

NEW

Check with your local distributor for availability of the new Neolith models.
Consulta con tu distribuidor local la disponibilidad de los nuevos modelos Neolith

Phedra

FUSION

Satin

3 MM
6 MM
12 MM

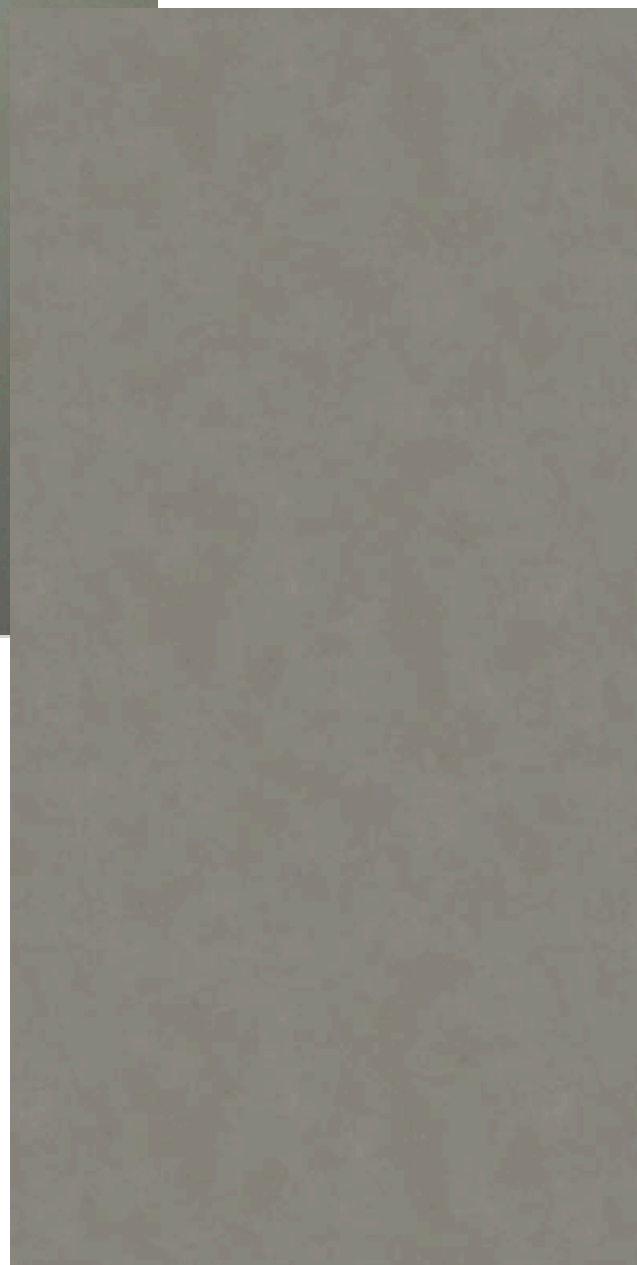

Full slab image / Imagen tabla completa

Wulong

FUSION

Slate

3 MM
6 MM
12 MM
20 MM



Full slab image / Imagen tabla completa

Pietra di Piombo

FUSION

Silk

3 MM
6 MM
12 MM
20 MM



Full slab image / Imagen tabla completa

Cement

FUSION

Satin

3 MM
6 MM
12 MM
20 MM

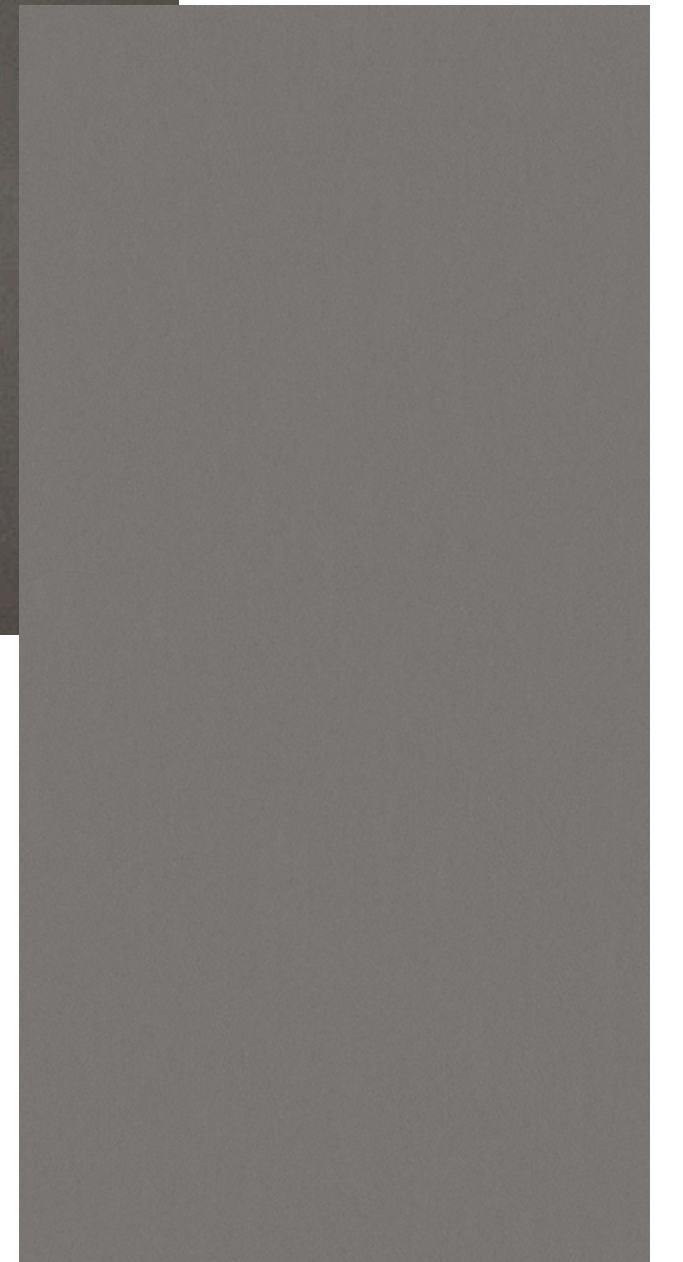

Full slab image / Imagen tabla completa

Mar del Plata

FUSION

Slate

6 MM
12 MM



Full slab image / Imagen tabla completa

Basalt Grey

FUSION

Satin

3 MM
6 MM
12 MM
20 MM

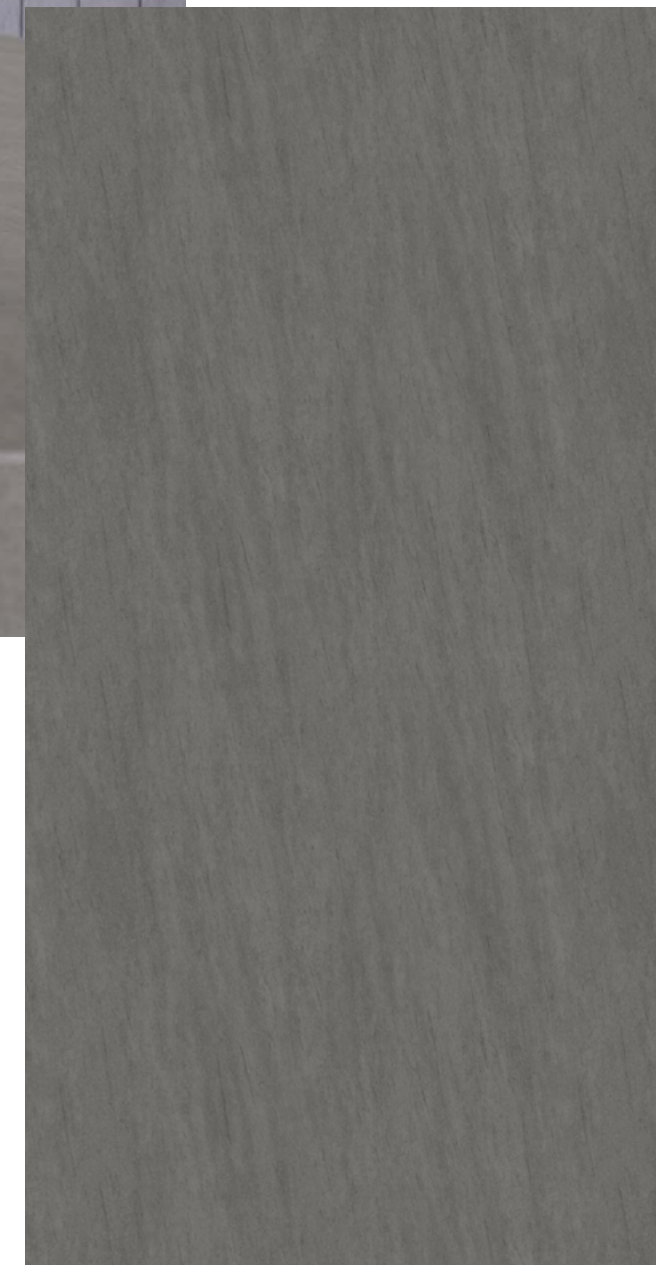

Full slab image / Imagen tabla completa

Barro

FUSION

Satin

3 MM
6 MM
12 MM
20 MM

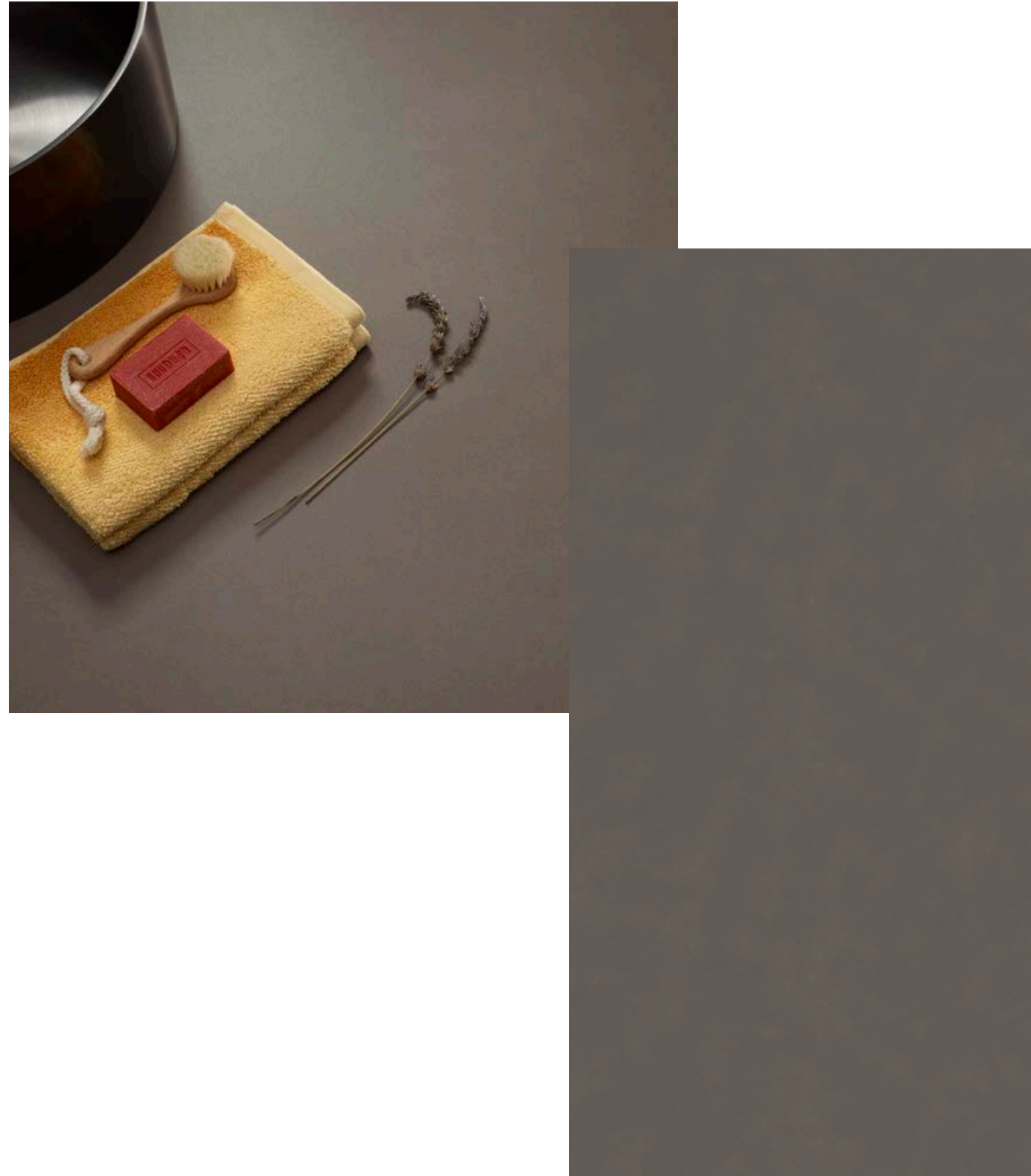

Full slab image / Imagen tabla completa

Pulpis

THE
NEW CLASSTONE

Silk

3 MM
6 MM
12 MM



Full slab image / Imagen tabla completa

Iron Corten

IRON

Satin

3 MM
6 MM
12 MM
20 MM

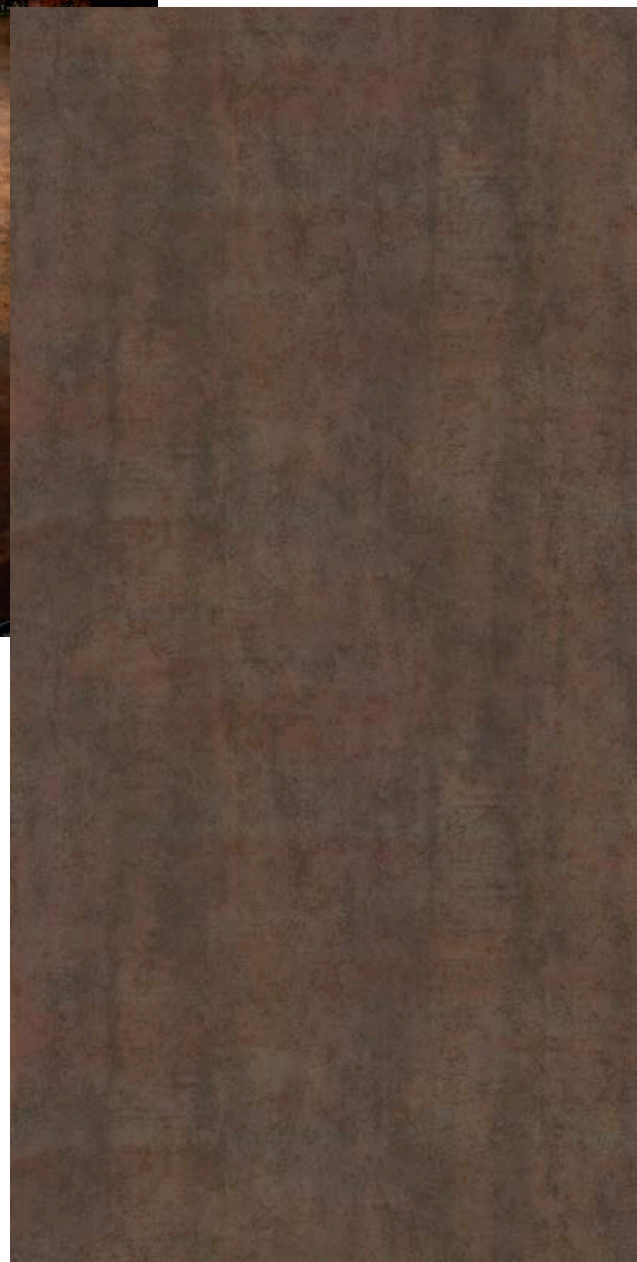

Full slab image / Imagen tabla completa

Iron Copper

IRON

Satin

3 MM
6 MM
12 MM

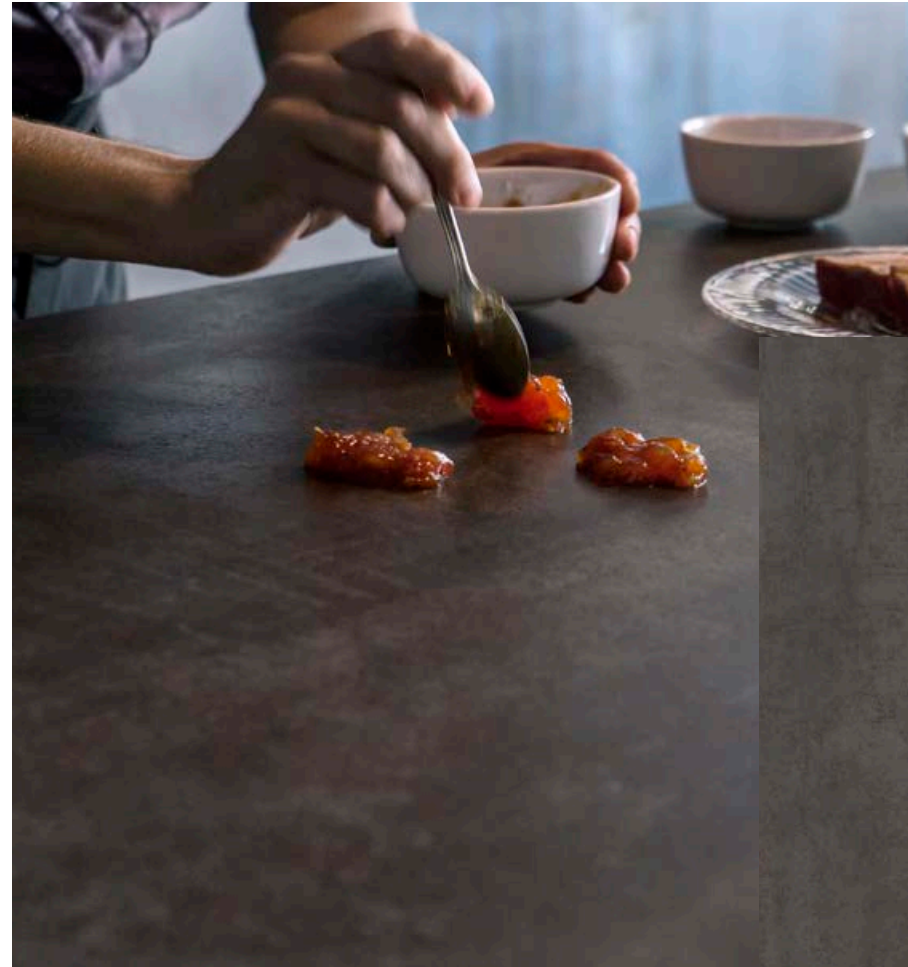

Full slab image / Imagen tabla completa

Pietra Grey

FUSION

Silk

6 MM
12 MM



Full slab image / Imagen tabla completa

Amazonico

THE
NEW CLASSTONE

Décor Polished
Slate

3 MM
6 MM
12 MM

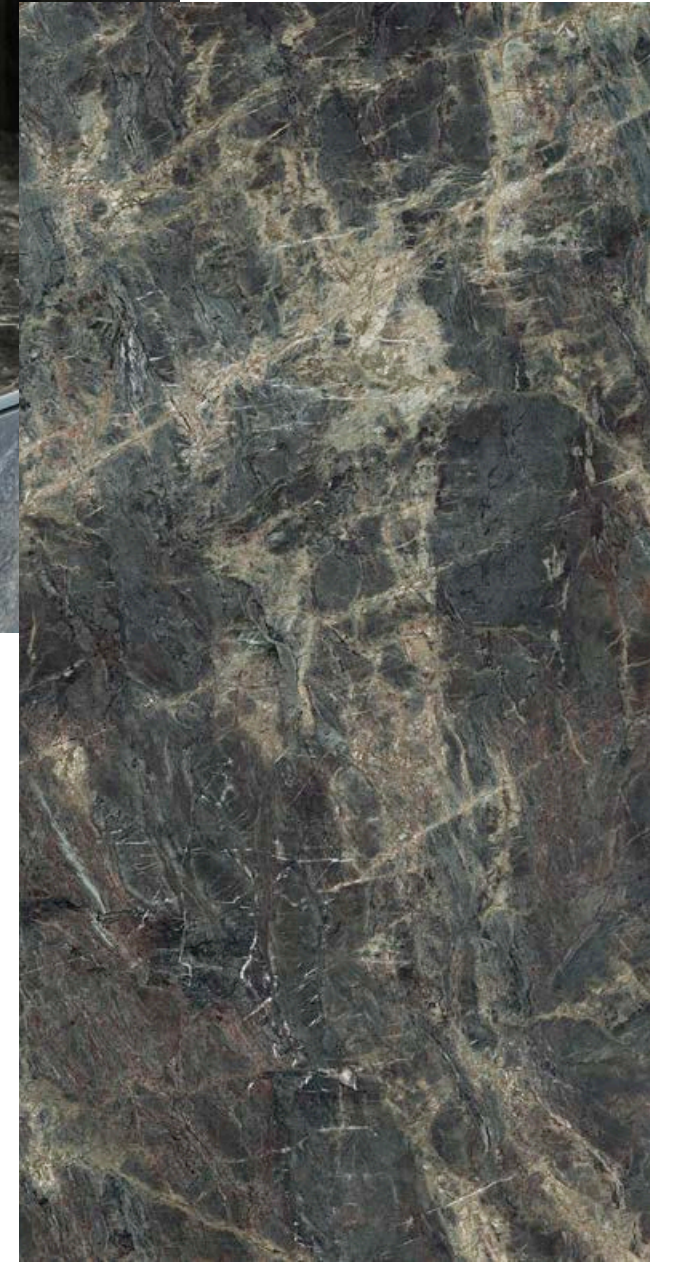

Full slab image / Imagen tabla completa

Aspen Grey

FUSION

Silk

3 MM
6 MM
12 MM
20 MM



Full slab image / Imagen tabla completa

Iron Grey

IRON

Satin

3 MM
6 MM
12 MM
20 MM

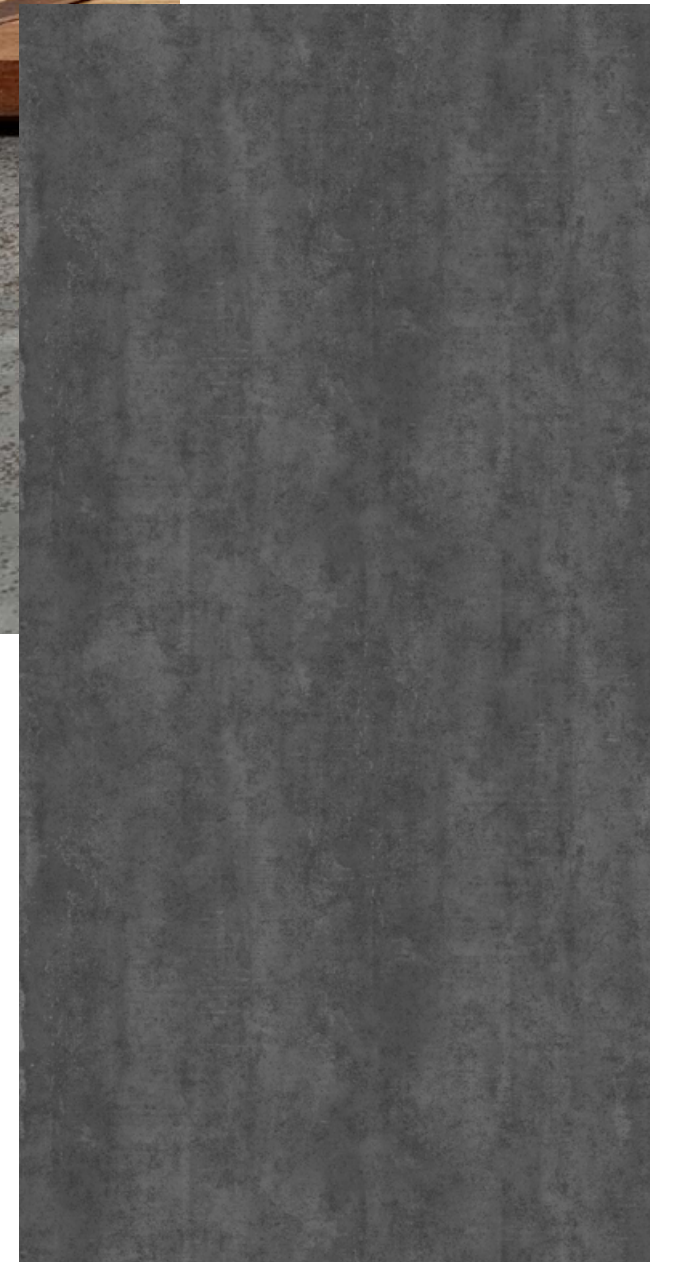

Full slab image / Imagen tabla completa

Krater

FUSION

Riverwashed
Slate

6 MM
12 MM



Full slab image / Imagen tabla completa

Sofia Cuprum

STEEL

Steel Touch

6 MM
12 MM
20 MM

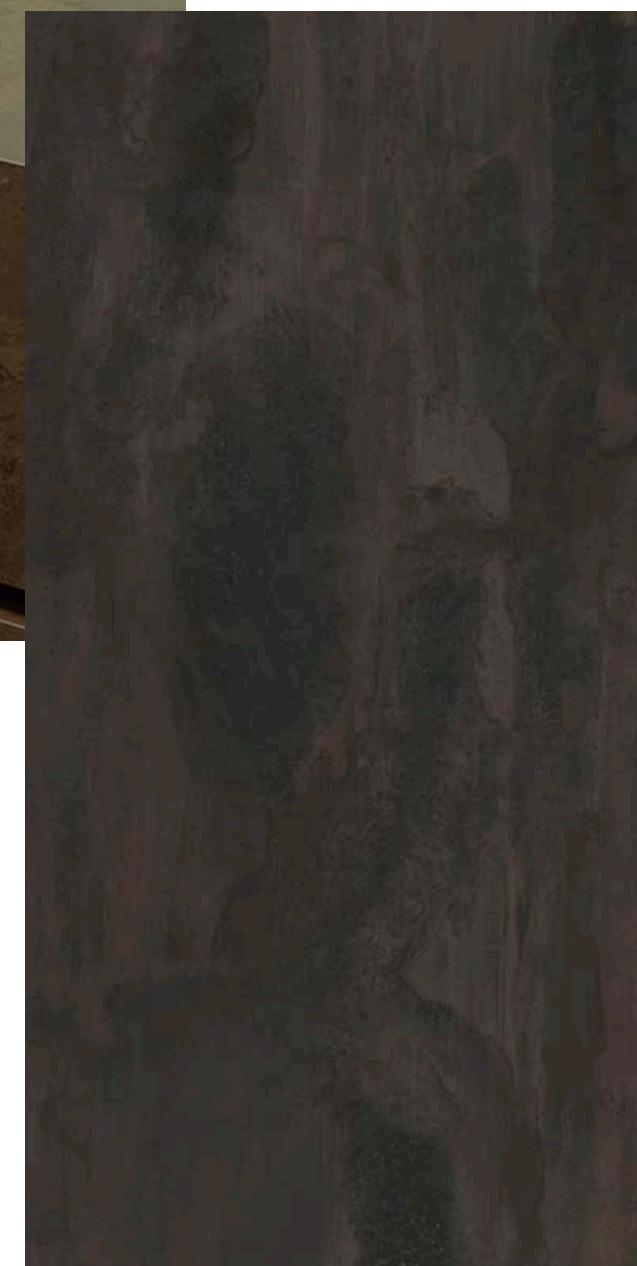

Full slab image / Imagen tabla completa



New formulation with up to 98% recycled material in the composition of Sofia Cuprum

Nueva formulación con hasta un 98% de material reciclado en la composición de Sofia Cuprum

Metropolitan

STEEL

Steel Touch

6 MM
12 MM
20 MM

Black Obsession

FUSION

Silk

6 MM
12 MM
20 MM



Full slab image / Imagen tabla completa

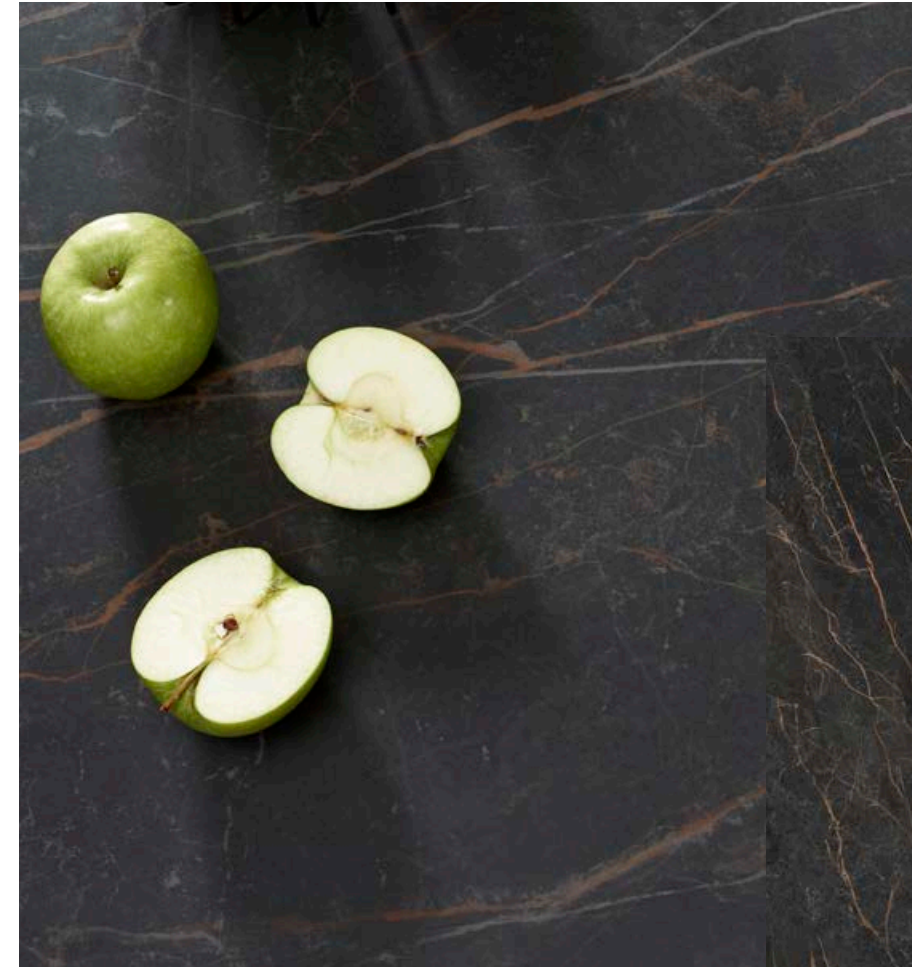

Full slab image / Imagen tabla completa



New formulation with up to 98% recycled material in the composition of Metropolitan
Nueva formulación con hasta un 98% de material reciclado en la composición de Metropolitan

Calatorao

THE
NEW CLASSTONE

Silk

3 MM
6 MM
12 MM
20 MM

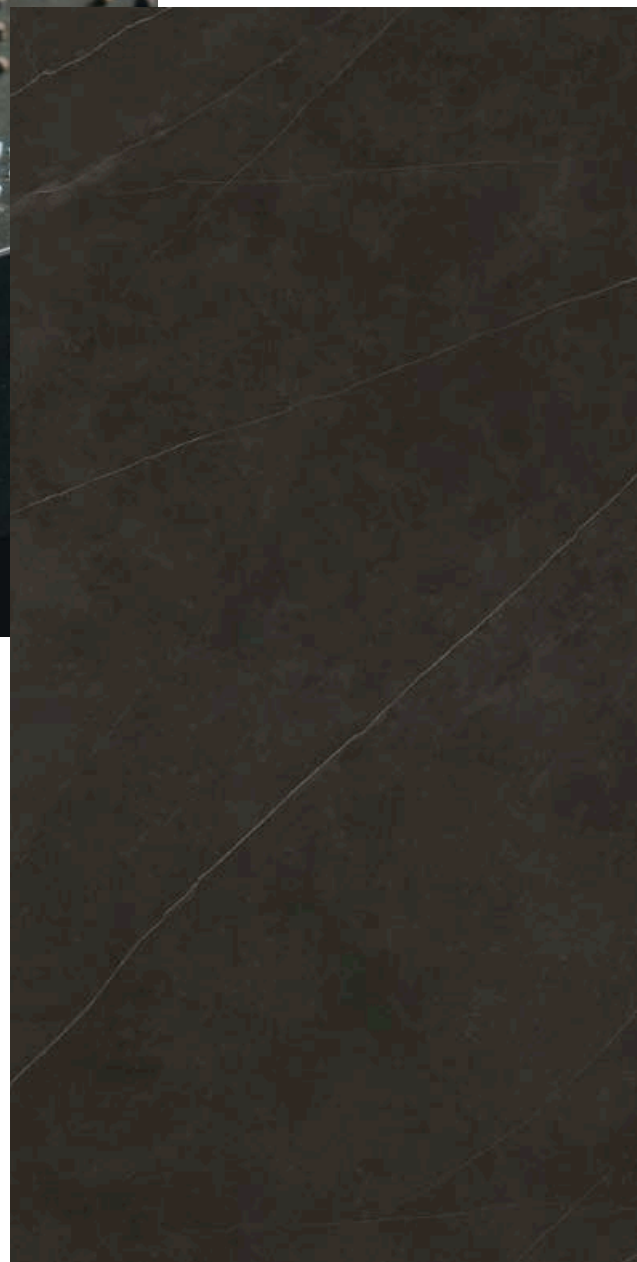

Full slab image / Imagen tabla completa

Nero Zimbabwe

FUSION

Riverwashed

3 MM
6 MM
12 MM
20 MM



Full slab image / Imagen tabla completa

Layla

THE
NEW CLASSTONE

Décor Polished
Slate

6 MM
12 MM
20 MM



Full slab image / Imagen tabla completa

Basalt Black

FUSION

Satin

3 MM
6 MM
12 MM
20 MM



New formulation with up to 98% recycled material in
the composition of Basalt Black
Nueva formulación con hasta un 98% de material
reciclado en la composición de Basalt Black

Full slab image / Imagen tabla completa

Nero

COLORFEEL

Satin

3 MM
6 MM
12 MM
20 MM

Niagara

THE
NEW CLASSTONE

Silk
Decor Polished

6 MM
12 MM
20 MM

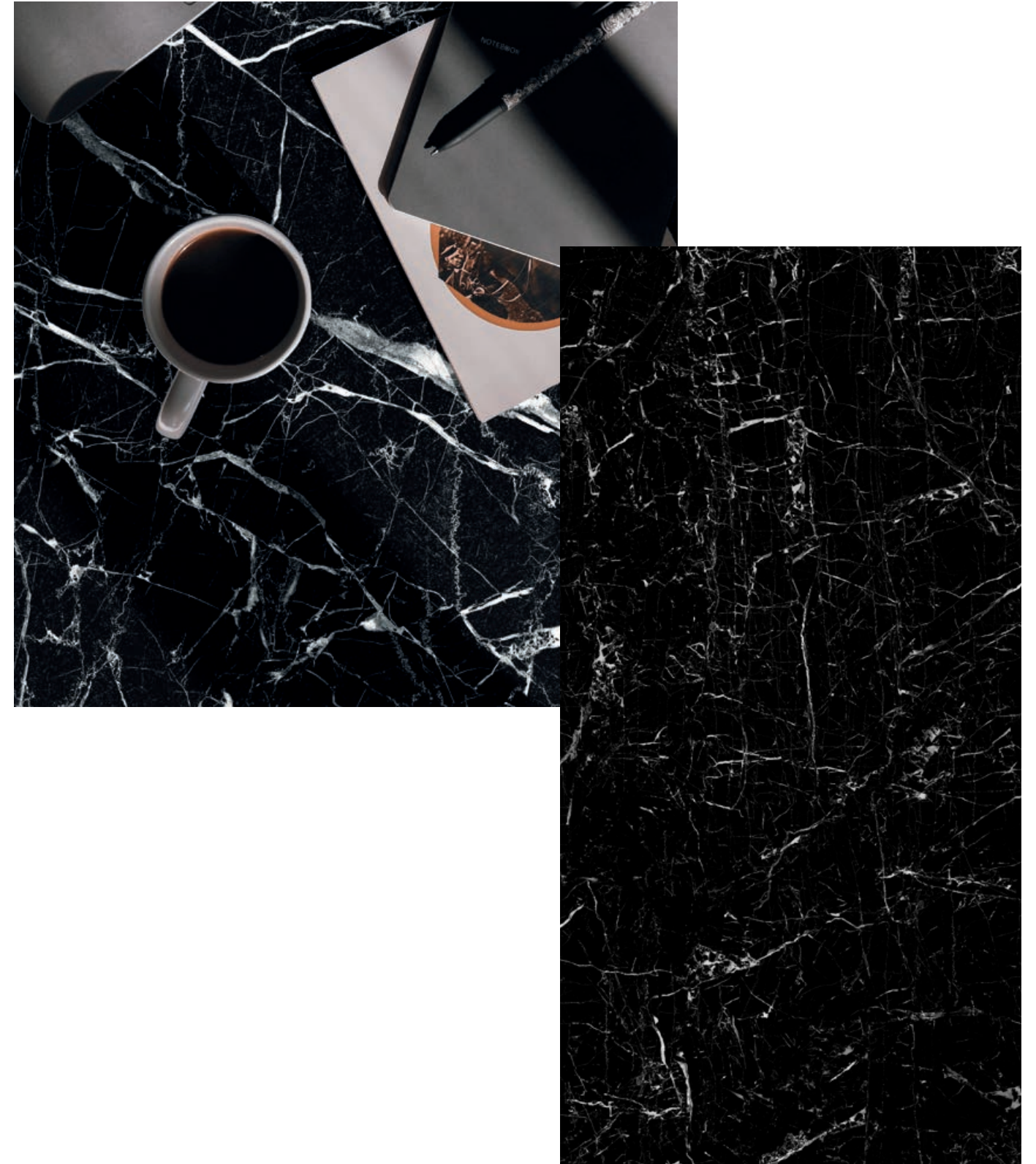

New formulation with up to 98% recycled material in the composition of Nero.

Nueva formulación con hasta un 98% de material reciclado en la composición de Nero.

Full slab image / Imagen tabla completa

Full slab image / Imagen tabla completa

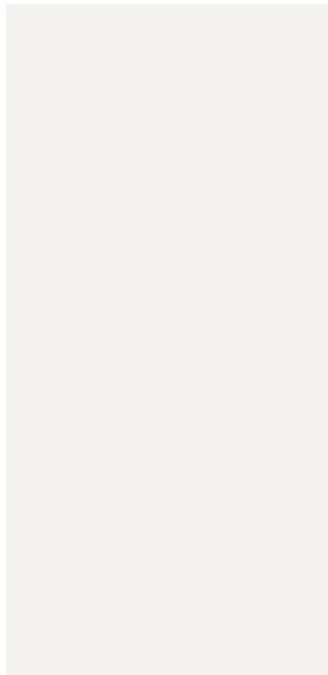

Artic White

	mm	Satin	Silk	Pol.	U. Soft	Riv. Slate
3.600 x 1.200	3	•	•			
3.200 x 1.500	6	•	•	•		
3.200 x 1.600	12	•	•	•		
	20					

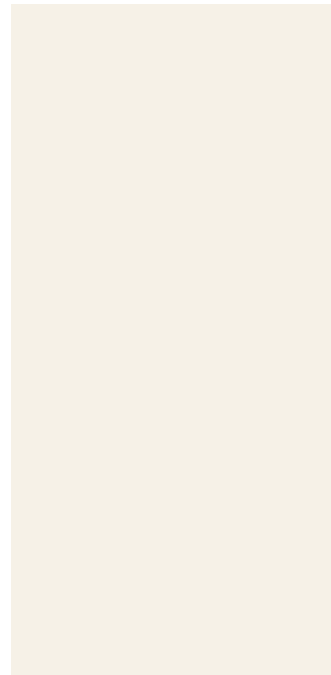

Just White

	mm	Satin	Silk	Pol.	U. Soft	Riv. Slate
3.600 x 1.200	3		•			
3.200 x 1.500	6		•			
3.200 x 1.600	12		•			
	20		•			

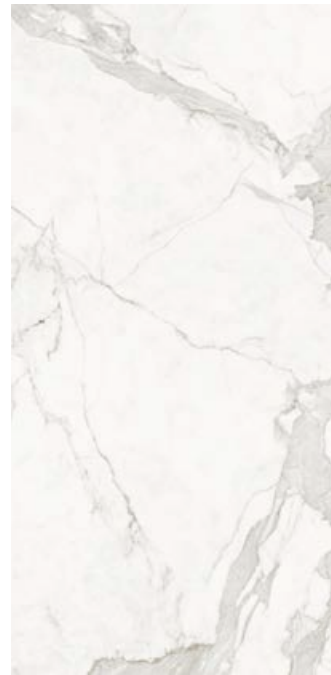

Estuario E01

	mm	Satin	Silk	Pol.	U. Soft	Riv. Slate
3.600 x 1.200	3		•			
3.200 x 1.500	6		•	•	•	
3.200 x 1.600	12		•	•	•	
	20		•	•	•	



Calacatta

	mm	Satin	Silk	Pol.	U. Soft	Riv. Slate
3.600 x 1.200	3		•			
3.200 x 1.500	6		•	•	•	
3.200 x 1.600	12		•	•	•	
	20		•	•	•	



Mont Blanc

	mm	Satin	Silk	Pol.	U. Soft	Riv. Slate
3.600 x 1.200	3		•			
3.200 x 1.500	6		•			
3.200 x 1.600	12		•			
	20		•			

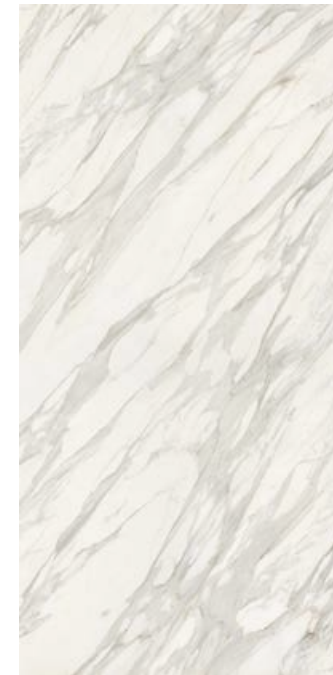

Calacatta Gold

	mm	Satin	Silk	Pol.	U. Soft	Riv. Slate
3.600 x 1.200	3		•			
3.200 x 1.500	6		•	•	•	
3.200 x 1.600	12		•	•	•	
	20		•	•	•	

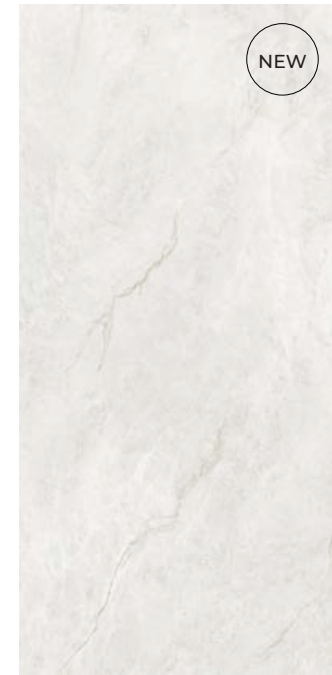

Everest Sunrise

	mm	Satin	Silk	Pol.	U. Soft	Riv. Slate
3.600 x 1.200	3					
3.200 x 1.500	6		•	•	•	
3.200 x 1.600	12		•	•	•	
	20		•	•	•	

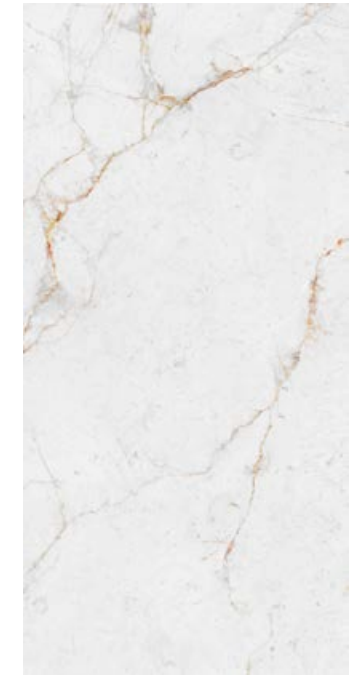

Abu Dhabi White

	mm	Satin	Silk	Pol.	U. Soft	Riv. Slate
3.600 x 1.200	3		•			
3.200 x 1.500	6		•	•	•	
3.200 x 1.600	12		•	•	•	
	20		•	•	•	

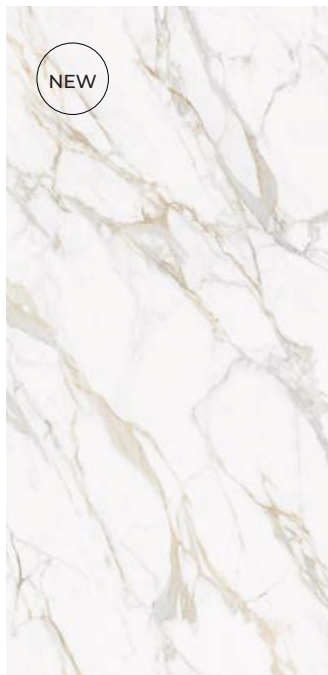

Calacatta Roma

	mm	Satin	Silk	Pol.	U. Soft	Riv. Slate
3.600 x 1.200	3					
3.200 x 1.500	6		•			
3.200 x 1.600	12		•			
	20		•			



Calacatta Royale

	mm	Satin	Silk	Pol.	U. Soft	Riv. Slate
3.600 x 1.200	3					
3.200 x 1.500	6		•	•	•	
3.200 x 1.600	12		•	•	•	
	20		•	•	•	



Iron Frost

	mm	Satin	Silk	Pol.	U. Soft	Riv. Slate
3.600 x 1.200	3		•			
3.200 x 1.500	6		•			
3.200 x 1.600	12		•			
	20		•			

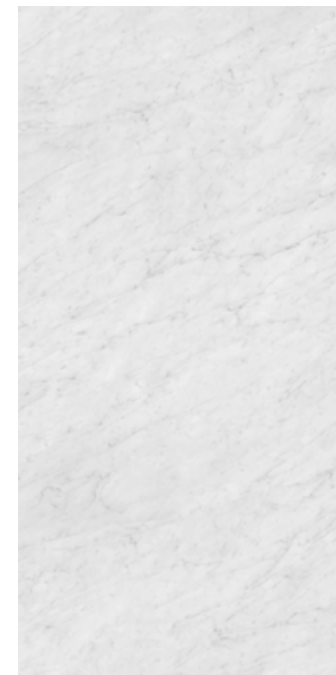

Blanco Carrara

	mm	Satin	Silk	Pol.	U. Soft	Riv. Slate
3.600 x 1.200	3		•			
3.200 x 1.500	6		•			
3.200 x 1.600	12		•			
	20		•			



Calacatta Luxe

	mm	Satin	Silk	Pol.	U. Soft	Riv. Slate
3.600 x 1.200	3					
3.200 x 1.500	6			•	•	
3.200 x 1.600	12			•	•	
	20			•	•	

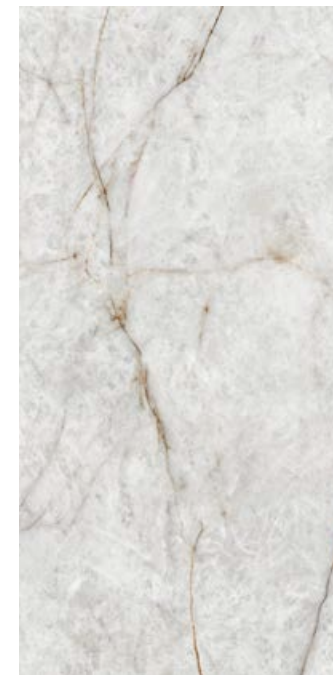

Himalaya Crystal

	mm	Satin	Silk	Pol.	U. Soft	Riv. Slate
3.600 x 1.200	3					
3.200 x 1.500	6		•	•	•	
3.200 x 1.600	12		•	•	•	
	20		•	•	•	



Retrostone

	mm	Satin	Silk	Pol.	U. Soft	Riv. Slate
3.600 x 1.200	3					
3.200 x 1.500	6		•			
3.200 x 1.600	12		•			
	20		•			



Calista

	mm	Satin	Silk	Pol.	U. Soft	Riv. Slate
3.600 x 1.200	3		•			
3.200 x 1.500	6		•	•	•	
3.200 x 1.600	12		•	•	•	
	20		•	•	•	



San Simone

	mm	Satin	Silk	Pol.	U. Soft	Riv. Slate
3.600 x 1.200	3					
3.200 x 1.500	6		•	•	•	
3.200 x 1.600	12		•	•	•	
	20		•	•	•	



Arabesque

	mm	Satin	Silk	Pol.	U. Soft	Riv. Slate
3.600 x 1.200	3		•			
3.200 x 1.500	6		•	•	•	
3.200 x 1.600	12		•	•	•	
	20		•	•	•	



Whitehaven

	mm	Satin	Silk	Pol.	U. Soft	Riv. Slate
3.600 x 1.200	3		•			
3.200 x 1.500	6			•	•	
3.200 x 1.600	12			•	•	
	20			•	•	



Colorado Dunes

	mm	Satin	Silk	Pol.	U. Soft	Riv. Slate
3.600 x 1.200	3		•			
3.200 x 1.500	6		•	•	•	
3.200 x 1.600	12		•	•	•	
	20		•	•	•	



Mirage

	mm	Satin	Silk	Pol.	U. Soft	Riv. Slate
3.600 x 1.200	3					
3.200 x 1.500	6		•			
3.200 x 1.600	12		•			
	20					



Summer Dala

	mm	Satin	Silk	Pol.	U. Soft	Riv. Slate
3.600 x 1.200	3					
3.200 x 1.500	6		•			
3.200 x 1.600	12		•			
	20					



La Bohème

	mm	Satin	Silk	Pol.	U. Soft	Riv. Slate
3.600 x 1.200	3					
3.200 x 1.500	6		•			
3.200 x 1.600	12		•			
	20					



Pietra di Osso

	mm	Satin	Silk	Pol.	U. Soft	Riv. Slate
3.600 x 1.200	3		•			
3.200 x 1.500	6		•			
3.200 x 1.600	12		•			
	20		•			



Arena

	mm	Satin	Silk	Pol.	U. Soft	Riv. Slate
3.600 x 1.200	3		•			
3.200 x 1.500	6		•			
3.200 x 1.600	12		•			
	20					

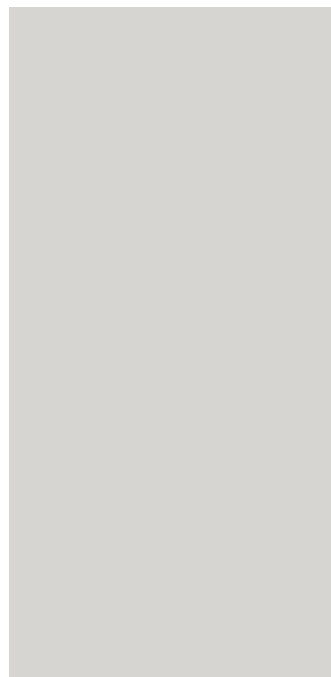

Perla

	mm	Satin	Silk	Pol.	U. Soft	Riv. Slate
3.600 x 1.200	3		•			
3.200 x 1.500	6		•			
3.200 x 1.600	12					
	20					



Strata Argentum

	mm	Satin	Silk	Pol.	U. Soft	Riv. Slate
3.600 x 1.200	3					•
3.200 x 1.500	6					•
3.200 x 1.600	12					•
	20					



Winter Dala

	mm	Satin	Silk	Pol.	U. Soft	Riv. Slate
3.600 x 1.200	3					
3.200 x 1.500	6		•			
3.200 x 1.600	12		•			
	20					



Shilin

	mm	Satin	Silk	Pol.	U. Soft	Riv. Slate
3.600 x 1.200	3		•			
3.200 x 1.500	6					•
3.200 x 1.600	12					•
	20					•



Alexandra

	mm	Satin	Silk	Pol.	U. Soft	Riv. Slate
3.600 x 1.200	3					
3.200 x 1.500	6		•	•	•	
3.200 x 1.600	12		•	•	•	
	20		•	•	•	



Pietra di Luna

	mm	Satin	Silk	Pol.	U. Soft	Riv. Slate
3.600 x 1.200	3		•			
3.200 x 1.500	6		•			
3.200 x 1.600	12		•			
	20		•			



Beton

	mm	Satin	Silk	Pol.	U. Soft	Riv. Slate
3.600 x 1.200	3					
3.200 x 1.500	6		•			•
3.200 x 1.600	12		•			
	20		•			

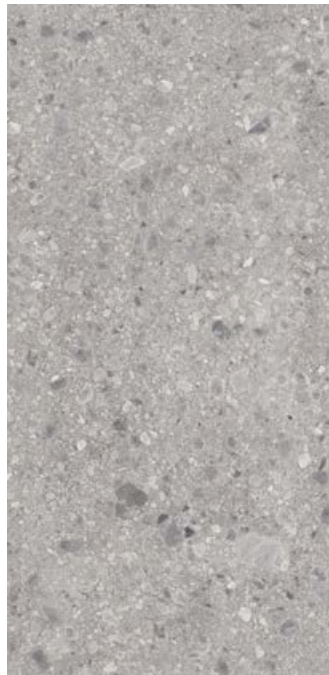

Terrazo Ceppo

	mm	Satin	Silk	Pol.	U. Soft	Riv. Slate
3.600 x 1.200	3					
3.200 x 1.500	6		•			
3.200 x 1.600	12 20		•			



New York New York

	mm	Satin	Silk	Pol.	U. Soft	Riv. Slate
3.600 x 1.200	3		•			
3.200 x 1.500	6		•			
3.200 x 1.600	12 20		•			



Zaha Stone

	mm	Satin	Silk	Pol.	U. Soft	Riv. Slate
3.600 x 1.200	3		•			
3.200 x 1.500	6		•			
3.200 x 1.600	12 20		•			



Cappadocia Sunset

	mm	Satin	Silk	Pol.	U. Soft	Riv. Slate
3.600 x 1.200	3		•			
3.200 x 1.500	6		•			
3.200 x 1.600	12 20		•			

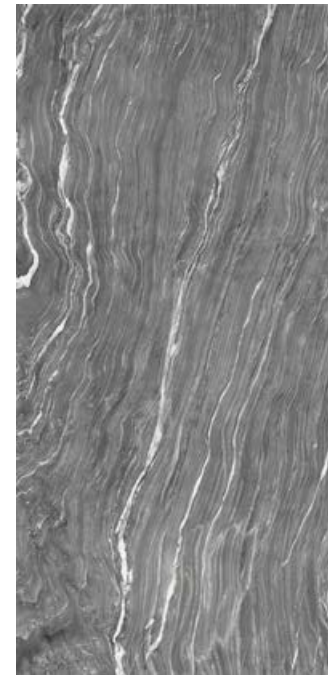

Mar del Plata

	mm	Satin	Silk	Pol.	U. Soft	Riv. Slate
3.600 x 1.200	3					
3.200 x 1.500	6					•
3.200 x 1.600	12 20					•



Basalt Grey

	mm	Satin	Silk	Pol.	U. Soft	Riv. Slate
3.600 x 1.200	3	•				
3.200 x 1.500	6	•				
3.200 x 1.600	12 20	•				



Barro

	mm	Satin	Silk	Pol.	U. Soft	Riv. Slate
3.600 x 1.200	3	•				
3.200 x 1.500	6	•				
3.200 x 1.600	12 20	•				

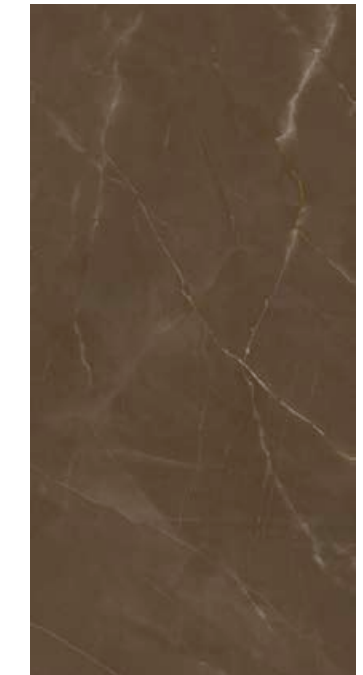

Pulpis

	mm	Satin	Silk	Pol.	U. Soft	Riv. Slate
3.600 x 1.200	3		•			
3.200 x 1.500	6		•			
3.200 x 1.600	12 20		•			



Phedra

	mm	Satin	Silk	Pol.	U. Soft	Riv. Slate
3.600 x 1.200	3	•				
3.200 x 1.500	6	•				
3.200 x 1.600	12 20	•				



Wulong

	mm	Satin	Silk	Pol.	U. Soft	Riv. Slate
3.600 x 1.200	3		•			
3.200 x 1.500	6		•			•
3.200 x 1.600	12 20		•			•



Pietra di Piombo

	mm	Satin	Silk	Pol.	U. Soft	Riv. Slate
3.600 x 1.200	3		•			
3.200 x 1.500	6		•			
3.200 x 1.600	12 20		•			



Cement

	mm	Satin	Silk	Pol.	U. Soft	Riv. Slate
3.600 x 1.200	3	•				
3.200 x 1.500	6	•				
3.200 x 1.600	12 20	•				



Iron Corten

	mm	Satin	Silk	Pol.	U. Soft	Riv. Slate
3.600 x 1.200	3	•				
3.200 x 1.500	6	•				
3.200 x 1.600	12 20	•				

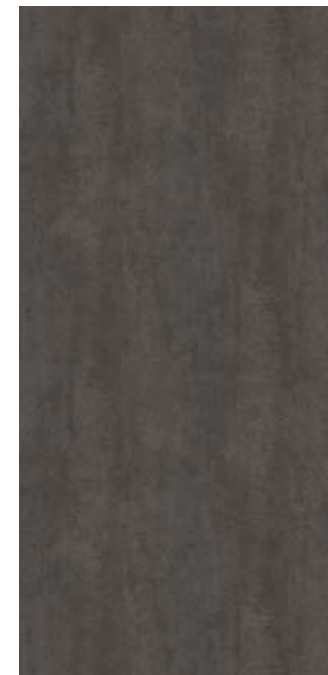

Iron Copper

	mm	Satin	Silk	Pol.	U. Soft	Riv. Slate
3.600 x 1.200	3	•				
3.200 x 1.500	6	•				
3.200 x 1.600	12 20	•				



Pietra Grey

	mm	Satin	Silk	Pol.	U. Soft	Riv. Slate
3.600 x 1.200	3					
3.200 x 1.500	6		•			
3.200 x 1.600	12 20		•			



Amazonico

	mm	Satin	Silk	Pol.	U. Soft	Riv. Slate
3.600 x 1.200	3		•			
3.200 x 1.500	6		•			•
3.200 x 1.600	12 20		•			•



Aspen Grey

	mm	Satin	Silk	Pol.	U. Soft	Riv. Slate
3.600 x 1.200	3		•			
3.200 x 1.500	6		•			
3.200 x 1.600	12		•			
	20		•			



Iron Grey

	mm	Satin	Silk	Pol.	U. Soft	Riv. Slate
3.600 x 1.200	3	•				
3.200 x 1.500	6	•				
3.200 x 1.600	12	•				
	20	•				



Krater

	mm	Satin	Silk	Pol.	U. Soft	Riv. Slate
3.600 x 1.200	3					
3.200 x 1.500	6					•
3.200 x 1.600	12					•
	20					•



Sofia Cuprum

	mm	Satin	Silk	Pol.	U. Soft	Steel Touch
3.600 x 1.200	3					•
3.200 x 1.500	6					•
3.200 x 1.600	12					•
	20					•



Layla

	mm	Satin	Silk	Pol.	U. Soft	Riv. Slate
3.600 x 1.200	3					
3.200 x 1.500	6			•		•
3.200 x 1.600	12			•		•
	20			•		•

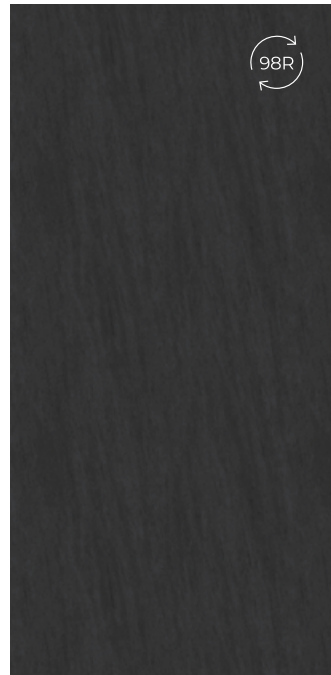

Basalt Black

	mm	Satin	Silk	Pol.	U. Soft	Riv. Slate
3.600 x 1.200	3	•				
3.200 x 1.500	6	•				
3.200 x 1.600	12	•				
	20	•				



Nero

	mm	Satin	Silk	Pol.	U. Soft	Riv. Slate
3.600 x 1.200	3	•				
3.200 x 1.500	6	•				
3.200 x 1.600	12	•				
	20	•				

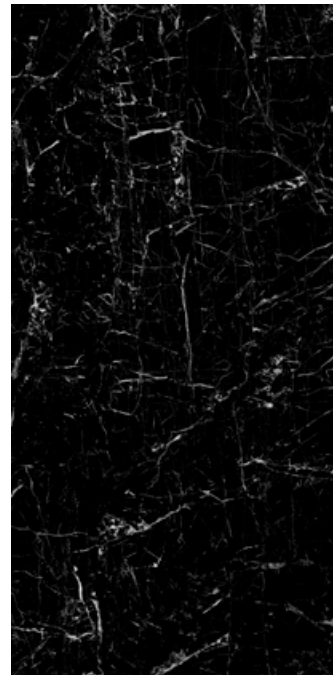

Niagara

	mm	Satin	Silk	Pol.	U. Soft	Riv. Slate
3.600 x 1.200	3					
3.200 x 1.500	6	•	•			
3.200 x 1.600	12	•	•			
	20	•	•			



Metropolitan

	mm	Satin	Silk	Pol.	U. Soft	Steel Touch
3.600 x 1.200	3					
3.200 x 1.500	6					•
3.200 x 1.600	12					•
	20					•



Black Obsession

	mm	Satin	Silk	Pol.	U. Soft	Riv. Slate
3.600 x 1.200	3					
3.200 x 1.500	6		•			
3.200 x 1.600	12		•			
	20		•			

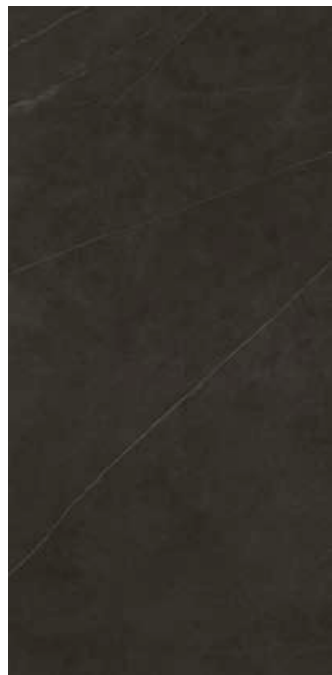

Calatorao

	mm	Satin	Silk	Pol.	U. Soft	Riv. Slate
3.600 x 1.200	3		•			
3.200 x 1.500	6		•			
3.200 x 1.600	12		•			
	20		•			

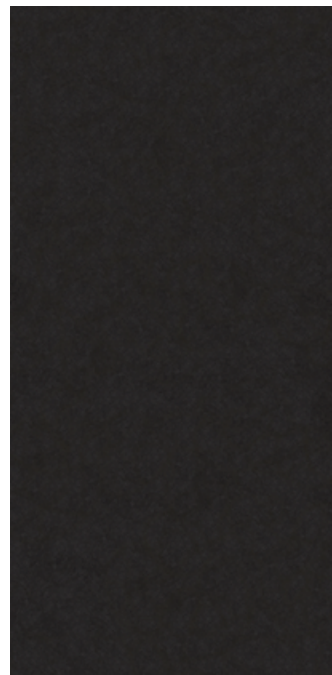

Nero Zimbabwe

	mm	Satin	Silk	Pol.	U. Soft	Riv. Slate
3.600 x 1.200	3					•
3.200 x 1.500	6					•
3.200 x 1.600	12					•
	20					•

Models only available for projects

Modelos solo disponibles para proyectos

Starting from 4,000 m² (43,000 sqft) for 3 and 6 mm, 3,000 m² (32,300 sqft) for 12 mm and 2,000 m² (21,500 sqft) for 20 mm of thickness, Neolith has several different models available to choose from for large-scale projects.

Consult your local distributor for more information.

A partir de 4.000 m² para 3 y 6 mm y 3.000 m² para 12 mm y 2.000 m² para 20 mm de espesor, Neolith tiene disponibles una serie de modelos distintos para elegir para grandes proyectos.

Consulta a tu distribuidor para más información.

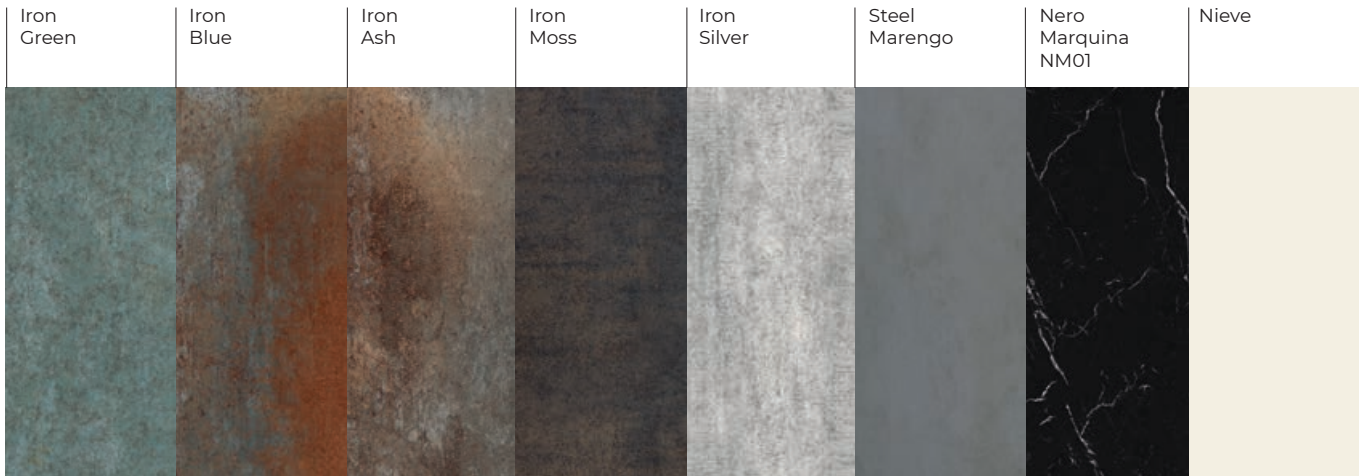



Bookmatch & Endmatch

Some Neolith models can come with a Bookmatched effect (mirror effect), just as when natural marble is extracted directly from a quarry. There is a Reverse option (marked with an "R") for each color in order to create Bookmatched options.

The Endmatch is a very special feature used in some New Classtone models. Using the same slab and just turning it 180°, it's possible to obtain continuing vein with an endless pattern.

Algunos modelos Neolith permiten la posibilidad de presentarse con efecto Bookmatch (efecto espejo) de la misma forma que el mármol natural es directamente extraído de una cantera. Para cada modelo se ha creado una versión reversa (marcada con "R") para presentar efectos Bookmatched.

El Endmatch es una característica muy especial que tienen algunos modelos en New Classtone Usando la misma tabla, sólo girándola 180°, puede obtenerse un patrón de vena continua sin fin.

Estatuario E01 Bookmatch

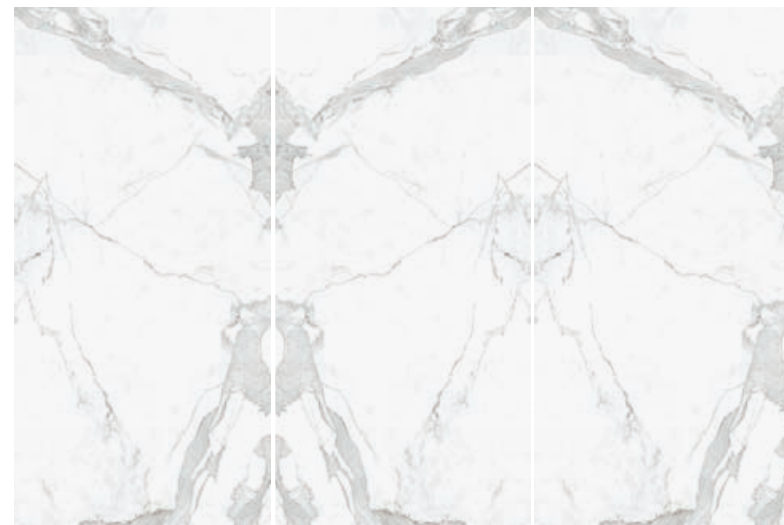

Estatuario E01

Estatuario E01R

Estatuario E01

Calacatta Gold Bookmatch



Calacatta Gold CG01

Calacatta Gold CG01R

Calacatta Gold CG01

Calacatta Gold Endmatch



Calacatta Gold CG01

Calacatta Gold CG01

Calacatta Gold CG01



Calacatta Roma Endmatch

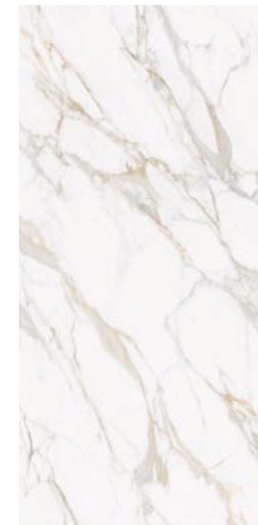

Calacatta Roma CR01

Calacatta Roma CR01

Calacatta Roma Bookmatch



Calacatta Roma CR01

Calacatta Roma CR01R

Calacatta Roma CR01



Bookmatch & Endmatch

Calacatta Royale Bookmatch



Calacatta Royale CR01

Calacatta Royale CR01R

Calacatta Royale CR01

Blanco Carrara Bookmatch

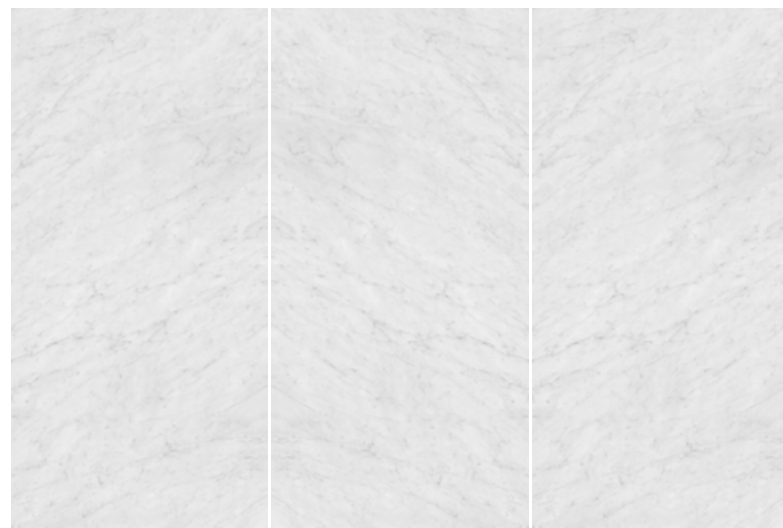

Blanco Carrara BC02

Blanco Carrara BC02R

Blanco Carrara BC02

Blanco Carrara Bc02 Endmatch

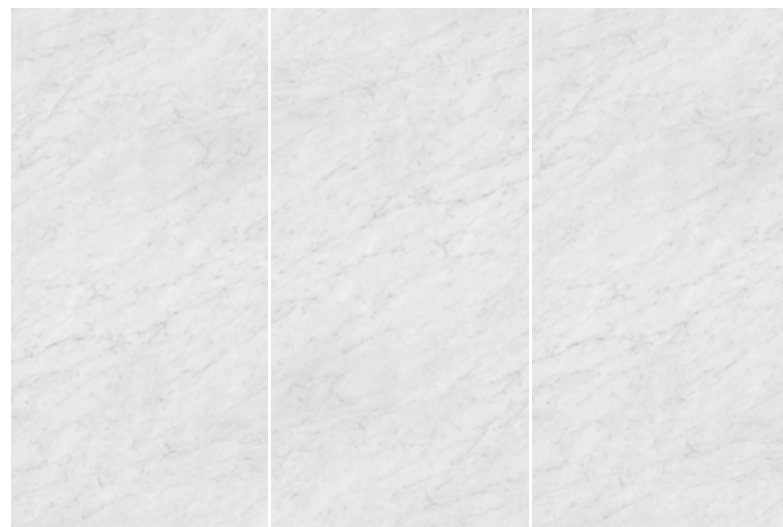

Blanco Carrara BC02

Blanco Carrara BC02

Blanco Carrara BC02



Calacatta Luxe Bookmatch



Calacatta Luxe CL01

Calacatta Luxe CL01R

Calacatta Luxe CL01

Calacatta Bookmatch



Calacatta C01R

Calacatta C01

Calacatta C01R

Calacatta Endmatch



Calacatta C01

Calacatta C01

Calacatta C01



Bookmatch & Endmatch

Arabesque Bookmatch



Arabesque AR01 Arabesque AR01R Arabesque AR01

Alexandra Bookmatch



Alexandra AX01 Alexandra AX01R Alexandra AX01

Whitehaven Bookmatch



Whitehaven WH01 Whitehaven WH01R Whitehaven WH01

Colorado Dunes Bookmatch



Colorado Dunes CD01 Colorado Dunes CD01R Colorado Dunes CD01

San Simone Bookmatch



San Simone SM01 San Simone SM01R San Simone SM01

Niagara Bookmatch

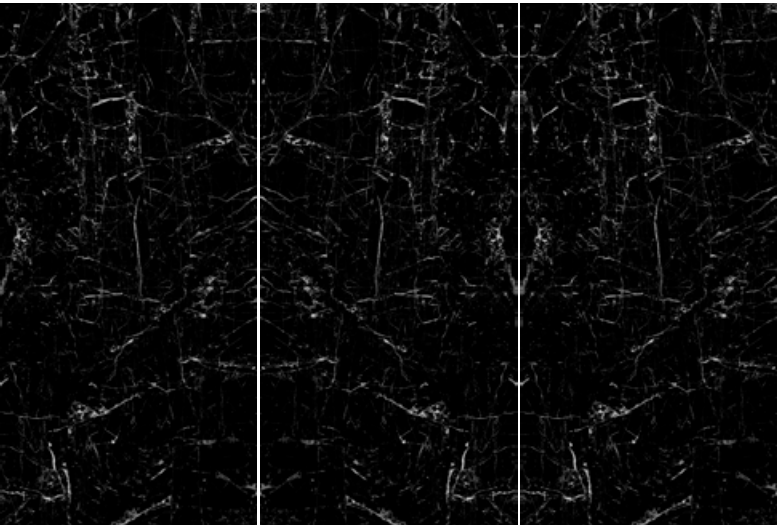

Niagara NG01 Niagara NG01R Niagara NG01

Design variants in Variantes de diseño 6 mm

To avoid repeating design in some Neolith models, variants have been created and will be shipped randomly when ordering these models, without the possibility of choosing the design.
Only available in 6 mm thickness.

Para evitar la repetición de diseño en algunos modelos Neolith, se han creado variantes que se enviarán de forma aleatoria, en los pedidos de estos colores, sin la posibilidad de elegir el diseño.
Esto está solo disponible en 6 mm de espesor.

Abu Dhabi White

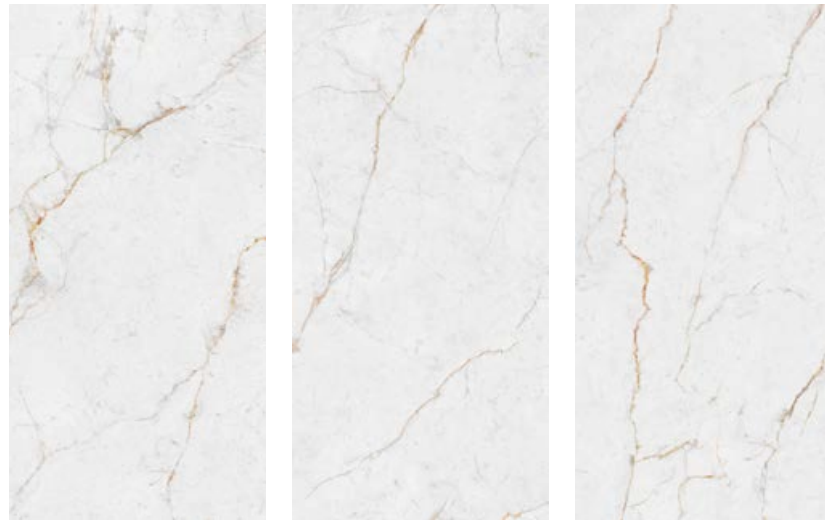

Himalaya Crystal



Mont Blanc



Everest Sunrise



Shilin



Design variants in / Variantes de diseño
6 mm

Retrostone



Strata Argentum



Summer Dala



Winter Dala



Mirage



Beton



Design variants in / Variantes de diseño 6 mm

New York- New York



Mar Del Plata

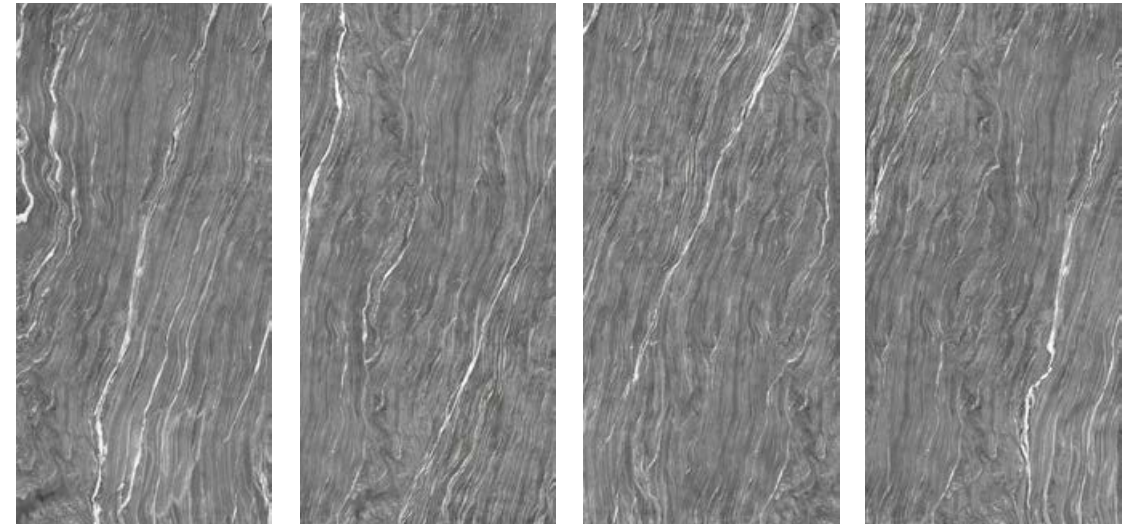

Zaha Stone

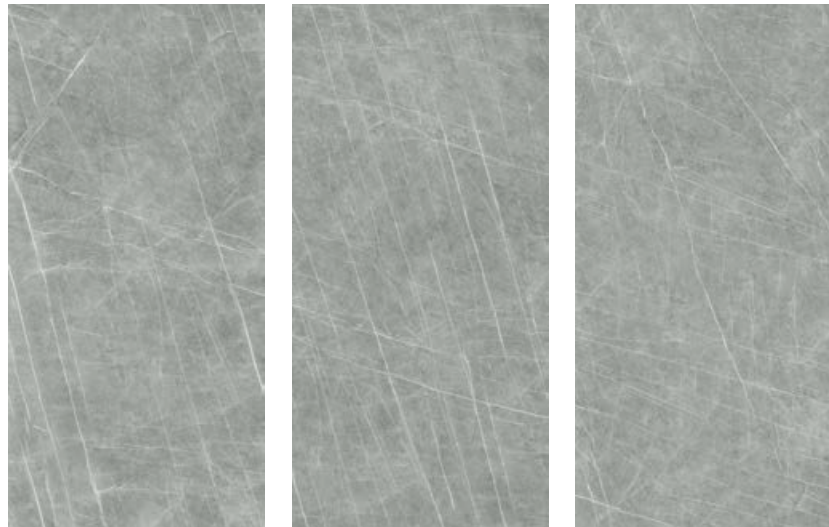

Aspen Grey



Cappadocia Sunset



Wulong



Design variants in / Variantes de diseño
6 mm

Amazonico

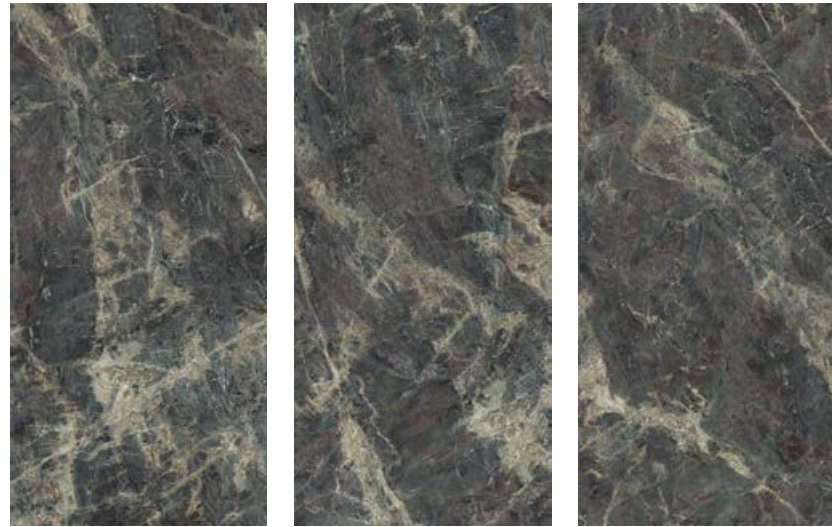

Calatorao



Layla



Metropolitan



Krater



Sofia Cuprum



General Summary Resumen General 2024

This table may be updated at any time.
Please check Neolith.com to get the latest version.

Esta tabla puede tener actualizaciones en cualquier momento.
Por favor consultar en Neolith.com para descargar la última versión.

OTHER FORMATS -
BUILD TO ORDER Delivery time,
please ask your commercial agent.

OTROS FORMATOS -
Plazo de entrega especial, consulte a su
agente comercial.

BOOKMATCH (R) MODELS -
BUILD TO ORDER Delivery time,
please ask your commercial agent.

MODELOS BOOKMATCH (R) -
Plazo de entrega especial, consulte a su
agente comercial.

○ New color 2024 / Color nuevo 2024
Check availability with your local distributor. / Consulta la disponibilidad con tu distribuidor.

		3200 x 1600 mm						3200 x 1500 mm						3600 x 1200 mm					
		12 and 20 mm						6 mm						3 mm					
		Satin	Silk	Decor Polished	U.Soft	Riv/Slate	Nano-tech Polished	Steel Touch	Satin	Silk	Decor Polished	U.Soft	Riv/Slate	Nano-tech Polished	Steel Touch	Satin	Silk	Decor Polished	Riv/Slate
COLORFEEL	Arctic White	12	20/12				20/12		6	6				6		3	3		
	Just White		20/12						6	6						3	3		
	Nero	20/12							6							3			
	Perla								6							3			
FUSION	Arena	12							6							3			
	Aspen Grey		20/12							6							3		
	Barro	20/12							6							3			
	Basalt Black	20/12							6							3			
	Basalt Grey	20/12							6							3			
	Beton		20/12							6			6				3		
	Black Obsession		20/12							6									
	● Cappadocia Sunset		20/12							6							3		
	Cement	20/12							6							3			
	Krater					12							6						
	Mar del Plata					12							6						
	Mirage		12							6									
	Nero Zimbabwe					20/12							6						3
	New York-New York		20/12								6						3		
	Phedra	12								6						3			
	Pierre Bleue									6									
	Pietra Grey		12							6									
Pietra di Luna		20/12							6							3			
Pietra di Osso		20/12							6							3			
Pietra di Piombo		20/12							6							3			
Retrostone		20/12							6										
Shilin					20/12							6				3			
Terrazo Ceppo		12							6										
Wulong					20/12							6				3			
Zaha Stone		20/12							6							3			
IRON	Iron Copper	12							6							3			
	Iron Corten	20/12							6							3			
	Iron Frost	12							6							3			
	Iron Grey	20/12							6							3			
TIMBER	La Bohème B01	12							6										
	Summer Dala		12						6										
	Winter Dala		12						6										
THE NEW CLASSTONE	Abu Dhabi White		20/12	12					6	6						3			
	Alexandra AX01		20/12	20/12	20/12				6	6	6								
	Amazonico					12				6		6				3			
	Arabesque AR01		20/12	20/12	20/12				6	6	6					3			
	Blanco Carrara BC02		12						6							3			
	Calacatta C01		20/12	20/12	20/12				6	6	6					3			
	Calacatta Gold CG01		12	12	12				6	6	6					3			
	Calacatta Luxe CL01			12	12					6	6	6							
	○ Calacatta Roma		20/12						6										
	Calacatta Royale CR01		20/12	20/12	20/12				6	6	6								
	Calatorao		20/12						6							3			
	Calista			20/12	20/12						6	6				3			
	Colorado Dunes CD01		20/12	20/12	20/12				6	6	6					3			
	Estuario E01		20/12	20/12	20/12				6	6	6					3			
	○ Everest Sunrise		20/12	20/12	20/12				6	6	6								
	Himalaya Crystal		20/12	20/12	20/12				6	6	6								
	Layla			20/12		20/12					6		6						
Mont Blanc		20/12						6							3				
Niagara NG01/NG01R		20/12	20/12					6	6										
Pulpis		12						6							3				
San Simone SM01		20/12	20/12	20/12				6	6	6									
Strata Argentum					12							6						3	
Whitehaven WH01			20/12	20/12					6	6					3				
STEEL	Metropolitan							20/12						6					
	Sofia Cuprum							20/12						6					

NEOLITH
touch.feel.live

P. I. Camí Fondo, Supoi 8, C/. dels Ibers, 31
12550 Almazora (Castellón) SPAIN
info@neolith.com | neolith.com

RESPONSIBLE TEAM
Neolith Branding Team

DESIGN
Neolith Team

NEOLITH

touch.feel.live